

ripay

TARIFA DE PRECIOS

PRICE LIST





HOSTELERÍA Y COLECTIVIDADES

CONTRACT FURNITURE & PUBLIC AREAS



Sillas y Taburetes | Bancadas | Mesas
Chairs & Tools | Benches | Tables

14

COMPLEMENTOS DE EXTERIOR

EXTERIOR COMPLEMENTS



Separadores | Parasoles | Vallas | Estufas
Terrace dividers | Umbrellas | Fences | Stoves

114

MOBILIARIO DE MADERA

WOODEN FURNITURE



Sillas y Taburetes | Mesas
Chairs & Tools | Tables

118

IMPORT



Sillas y Taburetes | Mesas
Chairs & Tools | Tables

126

Sillas Chairs

Bancadas Benches



Taburete Stools



Complementos de Exterior

Outdoor Accessories



Mesas de 75 cm de altura

Tables of 75 cm in height



Mobiliario de Madera

Wooden Furniture





Mod.1010
Mod.1012
Mod.1014
107

Mod.1040
108

Mod.1050
Mod.1052
Mod.1054
108

MESAS DE 42 CM DE ALTURA TABLES OF 42 CM IN HEIGHT



Mod.801
Mod.802
Mod.803
Mod.804
110



Mod.1001
Mod.1011
110

MESAS DE 110 CM DE ALTURA TABLES OF 110 CM IN HEIGHT

IMPORTACIÓN IMPORT



Mod.4001
087

Mod.1086
Mod.1087
089

Mod.1017
093

Mod.1019
Mod.1023
094

Mod.698
Mod.699
097

Mod.701
098

Mod.700
109

Mod.694
105

Mod.9995
111

Mod.1081
102

Mod.616
112

Mod.671
112

Mod.1092
088

Mod.721
112

Mod.1669
073

Mod.9988
099

Mod.693
105

Mod.702
109

SILLAS CHAIRS



Mod.1901
132

Mod.1904
128

Mod.1907
128

Mod.1882
132

Mod.1903
128

Mod.1906
128

Mod.1898
132

Mod.1899
132

Mod.1894
134

Mod.1902
133

Mod.1883
134

Mod.1965
134

Mod.219
133

Mod.217
133

Mod.105
136

Mod.1892
137

Mod.1879
137

MESAS TABLES



Mod.661
135

Mod.771
Mod.881
135

Mod.891
135

Mod.2450
Mod.2820
136

Mod.2180
136

NOVEDADES 2018
NEW 2018



HOSTELERÍA Y COLECTIVIDADES
CONTRACT FURNITURE & PUBLIC AREAS

Sillas - Taburetes 14 | Bancadas 66 | Mesas 72
Chairs - Stools 14 | Benches 66 | Tables 72





0169

Silla con estructura de acero termolacado en pintura de poliéster. Tubo de 22 ø. Asiento de madera de pino en los diferentes acabados según tarifa.
 Chair with steel structure thermo-lacquered in polyester paint. Tube of 22 ø. Pinewood seat in the different finishes according to catalog.



ESTRUCTURA FRAMEWORK	CÓDIGO CODE	MADERA WOOD
Pintura color blanco text. Colour white textured paint.	01691 1	53.15
Pintura color crema text. Colour cream textured paint.	01694 4	
Pintura color burdeos text. Colour bordeaux painted.	0169UTX UTX	
Pintura color chocolate. Colour chocolate painted.	0169Q Q	
Pintura color gris grafito. Colour gray graphite painted.	0169R R	
Pintura color negro text. Colour black textured paint.	01692 2	

Madera Pino Wood - M

MPH MPG MPT MPK MPB

Apilable Stackable

Interiores/cubierto Indoor / Covered



NEW





0569

Taburete con estructura de acero termolacado en pintura de poliéster. Tubo de 22 ø. Asiento de madera de pino en los diferentes acabados según tarifa.
 Armchair with steel structure thermo-lacquered in polyester paint. Tube of 22 ø. Pinewood seat in the different finishes according to catalog.



ESTRUCTURA FRAMEWORK	CÓDIGO CODE	
Pintura color blanco text. Colour white textured paint.	05691	1
Pintura color crema text. Colour cream textured paint.	05694	4
Pintura color burdeos text. Colour bordeaux painted.	0569UTX	UTX
Pintura color chocolate. Colour chocolate painted.	0569Q	Q
Pintura color gris grafito. Colour gray graphite painted.	0569R	R
Pintura color negro text. Colour black textured paint.	05692	2

MADERA
WOOD
52.00

Madera Pino Wood - M
MPG MPO MPT MPK MPB

T 72 | 33 x 33 | 4 | Interiores/cubierto Indoor / Covered

0469

Taburete con estructura de acero termolacado en pintura de poliéster. Tubo de 22 ø. Asiento de madera de pino en los diferentes acabados según tarifa.
 Armchair with steel structure thermo-lacquered in polyester paint. Tube of 22 ø. Pinewood seat in the different finishes according to catalog.



ESTRUCTURA FRAMEWORK	CÓDIGO CODE	
Pintura color blanco text. Colour white textured paint.	04691	1
Pintura color crema text. Colour cream textured paint.	04694	4
Pintura color burdeos text. Colour bordeaux painted.	0469UTX	UTX
Pintura color chocolate. Colour chocolate painted.	0469Q	Q
Pintura color gris grafito. Colour gray graphite painted.	0469R	R
Pintura color negro text. Colour black textured paint.	04692	2

MADERA
WOOD
52.00

Madera Pino Wood - M
MPG MPO MPT MPK MPB

T 46 | 33 x 33 | 3,16 | Interiores/cubierto Indoor / Covered

NEW



NEW



0167

Silla con estructura de acero termolacado en pintura de poliéster. Tubo de 22 ø. Asiento y respaldo Chapa de acero de 1,2 mm de espesor.
 Chair with steel structure thermo-lacquered in polyester paint. Tube of 22 ø. Seat and back in sheet steel of 1,2 mm thickness with different finishes according to catalog.



ESTRUCTURA FRAMEWORK	CÓDIGO CODE	
Pintura color blanco text. Colour white textured paint.	01671	1
Pintura color crema text. Colour cream textured paint.	01674	4
Pintura color burdeos text. Colour bordeaux painted.	0167UTX	UTX
Pintura color chocolate. Colour chocolate painted.	0167Q	Q
Pintura color gris grafito. Colour gray graphite painted.	0167R	R
Pintura color negro text. Colour black textured paint.	01672	2

CHAPA ACERO
SHEET STEEL

53.15



Apilable stackable
Interiores/cubierto Indoor / Covered

1169

Sillón con estructura de acero termolacado en pintura de poliéster. Tubo de 22 ø. Asiento de madera de pino en los diferentes acabados según tarifa.
 Armchair with steel structure thermo-lacquered in polyester paint. Tube of 22 ø. Pinewood seat in the different finishes according to catalog.



ESTRUCTURA FRAMEWORK	CÓDIGO CODE	
Pintura color blanco text. Colour white textured paint.	11691	1
Pintura color crema text. Colour cream textured paint.	11694	4
Pintura color burdeos text. Colour bordeaux painted.	1169UTX	UTX
Pintura color chocolate. Colour chocolate painted.	1169Q	Q
Pintura color gris grafito. Colour gray graphite painted.	1169R	R
Pintura color negro text. Colour black textured paint.	11692	2

MADERA
WOOD

66.60

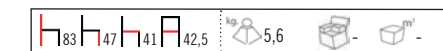

Madera Pino	Wood - M
MPG	MPO
MPT	MPK
MPB	

Apilable stackable
Interiores/cubierto Indoor / Covered

NEW



NEW



ripay

Posibilidad de personalizar la silla.





0567

Taburete con estructura de acero termolacado en pintura de poliéster. Tubo de 22 ø. Asiento chapa de acero de 1,2 mm de espesor.
Stool with steel structure thermo-lacquered in polyester paint. Tube of 22 ø. Seatt in sheet steel of 1,2 mm thickness with different finishes according to catalog.



NEW

ESTRUCTURA FRAMEWORK	CÓDIGO CODE	CHAPA ACERO SHEET STEEL
Pintura color blanco text. Colour white textured paint.	05671 1	52.00
Pintura color crema text. Colour cream textured paint.	05674 4	
Pintura color burdeos text. Colour bordeaux painted.	0567UTX UTX	
Pintura color chocolate. Colour chocolate painted.	0567Q Q	
Pintura color gris grafito. Colour gray graphite painted.	0567R R	
Pintura color negro text. Colour black textured paint.	05672 2	
T 72 33 x 33 4 - - Interiores/cubierto Indoor / Covered		

0467

Taburete con estructura de acero termolacado en pintura de poliéster. Tubo de 22 ø. Asiento chapa de acero de 1,2 mm de espesor.
Stool with steel structure thermo-lacquered in polyester paint. Tube of 22 ø. Seatt in sheet steel of 1,2 mm thickness with different finishes according to catalog.



ESTRUCTURA FRAMEWORK	CÓDIGO CODE	CHAPA ACERO SHEET STEEL
Pintura color blanco text. Colour white textured paint.	04671 1	52.00
Pintura color crema text. Colour cream textured paint.	04674 4	
Pintura color burdeos text. Colour bordeaux painted.	0467UTX UTX	
Pintura color chocolate. Colour chocolate painted.	0467Q Q	
Pintura color gris grafito. Colour gray graphite painted.	0467R R	
Pintura color negro text. Colour black textured paint.	04672 2	
T 46 33 x 33 3 - - Interiores/cubierto Indoor / Covered		





1167

Sillón con estructura de acero termolacado en pintura de poliéster. Tubo de 22 ø. Asiento y respaldo Chapa de acero de 1,2 mm de espesor.
 Armchair with steel structure thermo-lacquered in polyester paint. Tube of 22 ø. Seat and back in sheet steel of 1,2 mm thickness with different finishes according to catalog.



ESTRUCTURA FRAMEWORK	CÓDIGO CODE	
Pintura color blanco text. Colour white textured paint.	11671	1
Pintura color crema text. Colour cream textured paint.	11674	4
Pintura color burdeos text. Colour bordeaux painted.	1167UTX	UTX
Pintura color chocolate. Colour chocolate painted.	1167Q	Q
Pintura color gris grafito. Colour gray graphite painted.	1167R	R
Pintura color negro text. Colour black textured paint.	11672	2

CHAPA ACERO
SHEET STEEL

66.60



Apilable Stackable
 Interiores/cubierto Indoor / Covered

0027

Silla con estructura de acero, tubo de 22 mm. Acabado en pintura poliéster antioxidante.
 Chair with steel structure, 22 mm tube. Finished in antioxidant polyester paint.



ESTRUCTURA FRAMEWORK	CÓDIGO CODE	
Pintura color blanco text. Colour white textured paint.	00271	1
Pintura color crema text. Colour cream textured paint.	00274	4
Pintura color burdeos text. Colour bordeaux painted.	0027UTX	UTX
Pintura color chocolate. Colour chocolate painted.	0027Q	Q
Pintura color gris grafito. Colour gray graphite painted.	0027R	R
Pintura color negro text. Colour black textured paint.	00272	2

ESTRATIFICADO
STRATIFIED

68.40

Estratificado Stratified - E

EB EU EN
 EE EO EZ EW

Apilable stackable
 Interiores/cubierto Indoor / Covered



0029

Silla con estructura de acero, tubo de 22 mm. Acabado en pintura poliéster antioxidante.
 Chair with steel structure, 22 mm tube. Finished in antioxidant polyester paint.



ESTRUCTURA FRAMEWORK	CÓDIGO CODE	
Pintura color blanco text. Colour white textured paint.	00291	1
Pintura color crema text. Colour cream textured paint.	00294	4
Pintura color burdeos text. Colour bordeaux painted.	0029UTX	UTX
Pintura color chocolate. Colour chocolate painted.	0029Q	Q
Pintura color gris grafito. Colour gray graphite painted.	0029R	R
Pintura color negro text. Colour black textured paint.	00292	2

ESTRATIFICADO
STRATIFIED

68.40

Estratificado Stratified - E

EB EU EN
 EE EO EZ EW

Apilable Stackable
 Interiores/cubierto Indoor / Covered

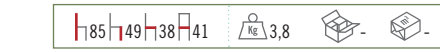

0556

Taburete con estructura de aluminio, tubo de 30 mm. Acabado en pintura poliéster antioxidante.
 Stool with steel structure, 30 mm tube. Finished in antioxidant polyester paint.



ESTRUCTURA FRAMEWORK	CÓDIGO CODE	
Pintura color blanco text. Colour white textured paint.	05561	1
Pintura color crema text. Colour cream textured paint.	05564	4
Pintura color burdeos text. Colour bordeaux painted.	0556UTX	UTX
Pintura color chocolate. Colour chocolate painted.	0556Q	Q
Pintura color gris grafito. Colour gray graphite painted.	0556R	R
Pintura color negro text. Colour black textured paint.	05562	2

COMPACTO
COMPACT

64.60

Compacto Compact - C

CB C6 CK CJ CT CU C3 CA
 CN CG CW CO CE

Interiores/cubierto Indoor / Covered



0300

Sillón de polipropileno en varios colores
Polypropylene chair in different colors

ESTRUCTURA FRAMEWORK	CÓDIGO CODE	POLIPROPILENO POLYPROPYLENE
Polipropileno Polypropylene	0300	19.75

Polipropileno Polypropylene - R



- Apilable Stackable
- Útil para exteriores Outdoor



2004

Sillón con carcasa de polipropileno y patas de aluminio pintadas en aluminio bicapa de 25 mm.
Armchair with framework of polypropylene and aluminium legs painted aluminium bilayer of 25mm

ESTRUCTURA FRAMEWORK	CÓDIGO CODE	POLIPROPILENO POLYPROPYLENE
Aluminio pintado en bicapa aluminizado Aluminized painted in Bilayer Aluminized	2004L	32.00

Polipropileno Polypropylene - R



- Apilable Stackable
- Útil para exteriores Outdoor



2011

Sillón con carcasa de polipropileno y patas de aluminio pintadas en aluminio bicapa de 25 mm.
 Armchair with framework of polypropylene and aluminium legs painted in bilayer of 25mm



ESTRUCTURA FRAMEWORK	CÓDIGO CODE
Aluminio pintado en bicapa aluminizado Aluminized painted in Bilayer Aluminized	2011L

POLIPROPILENO POLYPROPYLENE
32.00

Polipropileno Polypropylene - R

RB RK RJ RT RU RQ R3 RV RA RN RG

H 85 W 46 P 57 P 57 3,600 20 0,815

Apilable Stackable
 Útil para exteriores Outdoor



2012

Sillón con carcasa de polipropileno y patas de aluminio pintadas en aluminio bicapa de 20x20 mm.
 Armchair with framework of polypropylene and aluminium legs painted in bilayer of 20x20 mm



ESTRUCTURA FRAMEWORK	CÓDIGO CODE	POLIPROPILENO POLYPROPYLENE
Pintado en aluminio bicapa, o consultar colores <i>Painted in aluminium bilayer or see colors.</i>	2012L	33.50

Polipropileno Polypropylene - R



- Apilable Stackable
- Útil para exteriores Outdoor



2016

Sillón con carcasa de polipropileno y patas de aluminio pintadas en aluminio bicapa de 25 mm ø.
 Armchair with framework of polypropylene and aluminium legs painted in bilayer of 25 mm ø



ESTRUCTURA FRAMEWORK	CÓDIGO CODE	POLIPROPILENO POLYPROPYLENE
Pintado en aluminio bicapa, o consultar colores <i>Painted in aluminium bilayer or see colors.</i>	2016L	32.00

Polipropileno Polypropylene - R



- Apilable Stackable
- Útil para exteriores Outdoor

2018

Silla con carcasa de polipropileno y patas de aluminio pintadas en aluminio bicapa de 25 mm ø.
 Chair with framework of polypropylene and aluminium legs painted in bilayer of 25 mm ø



ESTRUCTURA FRAMEWORK	CÓDIGO CODE	POLIPROPILENO POLYPROPYLENE
Pintado en aluminio bicapa, o consultar colores <i>Painted in aluminium bilayer or see colors.</i>	2018L	29.80

Polipropileno Polypropylene - R



- Apilable Stackable
- Útil para exteriores Outdoor



2019

Sillón con carcasa de polipropileno y patas de aluminio pintadas en aluminio bicapa de 25 mm.
 Armchair with framework of polypropylene and aluminium legs painted in bilayer of 25mm



ESTRUCTURA FRAMEWORK	CÓDIGO CODE	POLIPROPILENO POLYPROPYLENE
Aluminio pintado en bicapa aluminizado Aluminized painted in bilayer	2019L	36.00

Polipropileno Polypropylene - R

- RB
- RK
- RJ
- RT
- RU
- RQ
- R3
- RV
- RA
- RN
- RG

H80 H44 H55 H60 Kg 3,320 12 0,815

- Apilable Stackable
- Útil para exteriores Outdoor



0180

Silla con estructura de acero con patas conicadas cuadradas y pintadas en aluminio bicapa o cromado de 25 mm. Asiento y respaldo en polipropileno.
 Chair with steel structure with square conical legs and painted in aluminium bilayer or chrome of 25 mm. Seat and back in polypropylene.



ESTRUCTURA FRAMEWORK	CÓDIGO CODE
Pintado en aluminio bicapa, o consultar colores Painted in aluminium bilayer or see colors.	0180L 01801
Cromado Chrome	0180C

H83,5 H46 H51 H44 Kg 4,700 4 0,295

- Apilable Stackable
- Útil para exteriores Outdoor

POLIPROPILENO POLYPROPYLENE	POLIPIEL (solo asiento) IMITATION LEATHER (Seat only)
59.80	75.80
75.80	91.80

Polipropileno Polypropylene - R

- RB
- RK
- RJ
- RT
- RU
- RQ
- R3
- RA
- RG
- RN

Polipiel Imitation leather - L

- LB
- LK
- LJ
- LU
- LQ
- L3
- LA
- LL
- LN

Más detalle en el apartado de acabados More detail in the finishing section





1800

Sillón con estructura de acero con patas conificadas cuadradas y pintadas en aluminio bicapa o cromado de 25 mm. Asiento y respaldo en polipropileno.
 Armchair with steel structure with square conical legs and painted in aluminium bilayer or chrome of 25 mm. Seat and back in polypropylene.

ESTRUCTURA FRAMEWORK	CÓDIGO CODE
Pintado en aluminio bicapa, o consultar colores <i>Painted in aluminium bilayer or see colors.</i>	1800L 18001
Cromado <i>Chrome</i>	1800C

POLIPROPILENO POLYPROPYLENE	POLIPIEL (solo asiento) IMITATION LEATHER (Seat only)
73.00	88.00
90.00	103.00



H 83,5 | h 46 | h 45 | F 55 | 5,000 | 4 | 0,406

- Apilable Stackable
- Útil para exteriores Outdoor



- Polipropileno Polypropylene - R**
 RB RK RJ RT RU RQ R3 RA RG RN
- Polipiel Imitation leather - L**
 LB LK LJ LU LQ L3 LA LL LN
- Mas detalle en el apartado de acabados *More detail in the finishing section*

0280

Sillón con estructura de acero con patas conificadas cuadradas y pintadas en aluminio bicapa o cromado de 25 mm. Apoyabrazos abatible. Asiento y respaldo en polipropileno.
 Armchair with steel structure with square conical legs and painted in aluminium bilayer or chrome of 25 mm. Folding armrest. Seat and back in polypropylene.

ESTRUCTURA FRAMEWORK	CÓDIGO CODE
Pintado en aluminio bicapa, o consultar colores <i>Painted in aluminium bilayer or see colors.</i>	0280L

POLIPROPILENO POLYPROPYLENE	POLIPIEL (solo asiento) IMITATION LEATHER (Seat only)
88.00	108.00



H 83,5 | h 46 | h 45 | F 55 | 6,230 | 1 | 0,310

- Útil para exteriores Outdoor



- Polipropileno Polypropylene - R**
 RB RK RJ RT RU RQ R3 RA RG RN
- Polipiel Imitation leather - L**
 LB LK LJ LU LQ L3 LA LL LN
- Mas detalle en el apartado de acabados *More detail in the finishing section*



0518



Taburete con estructura de acero con patas conificadas cuadradas y pintadas en aluminio bicapa o cromado de 25 mm. Asiento y respaldo en polipropileno.
 Stool with steel structure with square conical legs and painted in aluminium bilayer or chrome of 25 mm. Seat and back in polypropylene.

ESTRUCTURA FRAMEWORK	CÓDIGO CODE
Pintado en aluminio bicapa, o consultar colores <i>Painted in aluminium bilayer or see colors.</i>	0518L 05181
Cromado <i>Chrome</i>	0518C

H 107 W 45 P 44 Kg 6,830 1 0,288

Útil para exteriores Outdoor

POLIPROPILENO POLYPROPYLENE	POLIPIEL (solo asiento) IMITATION LEATHER (Seat only)
89.00	110.00
109.00	129.00

Polipropileno Polypropylene - R

RB RK RJ RT RU RQ R3 RA RG RN

Polipiel Imitation leather - L

LB LK LJ LU LQ L3 LA LL LN

Más detalle en el apartado de acabados More detail in the finishing section

0528



Taburete con estructura de acero con patas conificadas cuadradas y pintadas en aluminio bicapa o cromado de 25 mm. Asiento y respaldo en polipropileno.
 Stool with steel structure with square conical legs and painted in aluminium bilayer or chrome of 25 mm. Seat and back in polypropylene.

ESTRUCTURA FRAMEWORK	CÓDIGO CODE
Pintado en aluminio bicapa, o consultar colores <i>Painted in aluminium bilayer or see colors.</i>	0528L 05281
Cromado <i>Chrome</i>	0528C

H 107 W 45 P 55 Kg 6,830 1 0,288

Útil para exteriores Outdoor

POLIPROPILENO POLYPROPYLENE	POLIPIEL (solo asiento) IMITATION LEATHER (Seat only)
104.00	124.00
124.00	143.00

Polipropileno Polypropylene - R

RB RK RJ RT RU RQ R3 RA RG RN

Polipiel Imitation leather - L

LB LK LJ LU LQ L3 LA LL LN

Más detalle en el apartado de acabados More detail in the finishing section



0216

Z10 · Silla con estructura de acero pintada en aluminio bicapa o cromada de 18 mm. y carcasa de polipropileno.
Chair with steel structure painted in aluminium bilayer or chromed of 18 mm. and polypropylene housing.



ESTRUCTURA FRAMEWORK	CÓDIGO CODE
Pintado en aluminio bicapa, o consultar colores <i>Painted in aluminium bilayer or see colors.</i>	0216L
Cromado <i>Chrome</i>	0216C

POLIPROPILENO POLYPROPYLENE
63.00
71.00

h 82 | w 46 | d 49 | 49 | 5,000 | 4 | 0,261

Apilable Stackable
 Útil para exteriores Outdoor

Polipropileno Polypropylene · R

RB RK RJ RT RU R3 RN



2005

Silla con estructura de acero pintada en aluminio bicapa o cromada de 18 mm. y carcasa de polipropileno.
Chair with steel structure painted in aluminium bilayer or chromed of 18 mm. and polypropylene housing.



ESTRUCTURA FRAMEWORK	CÓDIGO CODE
Pintado en aluminio bicapa, o consultar colores <i>Painted in aluminium bilayer or see colors.</i>	2005L
Cromado <i>Chrome</i>	2005C

POLIPROPILENO POLYPROPYLENE
55.00
63.00

h 74 | w 46 | d 52 | 54 | 4,000 | 1 | 0,194

Apilable Stackable
 Útil para exteriores Outdoor

Polipropileno Polypropylene · R

RB RK RJ RT RU R3 RN

0116

Silla con estructura de acero pintada en aluminio bicapa de 20 mm. Asiento y respaldo en polipropileno.
Chair with steel structure painted in aluminium bilayer of 20mm. Seat and chair back in polypropylene.



ESTRUCTURA FRAMEWORK	CÓDIGO CODE
Pintado en aluminio bicapa, o consultar colores <i>Painted in aluminium bilayer or see colors.</i>	0116L

POLIPROPILENO POLYPROPYLENE
53.00

h 82 | w 44 | d 44 | 49 | 4,000 | 2 | 0,295

Apilable Stackable
 Útil para exteriores Outdoor

Polipropileno Polypropylene · R

RK RU RA RT RV

1875

Sillón con estructura de acero pintada en aluminio bicapa de 20 mm. Asiento y respaldo en polipropileno.
Armchair with steel structure painted in aluminium bilayer of 20mm. Seat and chair back in polypropylene.



ESTRUCTURA FRAMEWORK	CÓDIGO CODE
Pintado en aluminio bicapa, o consultar colores <i>Painted in aluminium bilayer or see colors.</i>	1875L

POLIPROPILENO POLYPROPYLENE
66.00

h 82 | w 44 | d 44 | 49 | 4,000 | 2 | 0,295

Apilable Stackable
 Útil para exteriores Outdoor

Polipropileno Polypropylene · R

RK RU RA RT RV

0044



Silla con estructura de acero pintada en aluminio bicapa, negro o cromado de 25 mm. Asiento y respaldo en poliuretano.
Chair with steel structure painted in aluminium bilayer, black or chrome of 25 mm. Seat and chair back in polyurethane.

ESTRUCTURA FRAMEWORK	CÓDIGO CODE
Pintado en aluminio bicapa, o consultar colores <i>Painted in aluminium bilayer or see colors.</i>	0044L 0044N
Cromado <i>Chrome</i>	0044C

POLIURETANO
POLYURETHANE

110.25

116.55

h81 h45 h40 h45 5,900 2 0,212

Apilable Stackable
 Sólo en interiores Indoor

Poliuretano Polyurethane - I

1180



Sillón con estructura de acero pintada en aluminio bicapa, negro o cromado de 25 mm. Asiento y respaldo en poliuretano.
Armchair with steel structure painted in aluminium bilayer, black or chrome of 25 mm. Seat and chair back in polyurethane.

ESTRUCTURA FRAMEWORK	CÓDIGO CODE
Pintado en aluminio bicapa, o consultar colores <i>Painted in aluminium bilayer or see colors.</i>	1180L 1180N
Cromado <i>Chrome</i>	1180C

POLIURETANO
POLYURETHANE

129.15

136.50

h74 h43 h55 h54 7,600 2 0,265

Apilable Stackable
 Sólo en interiores Indoor

Poliuretano Polyurethane - I

0580



Stool con estructura de acero pintada en aluminio bicapa, negro o cromado de 25 mm. Asiento y respaldo en poliuretano.
Armchair with steel structure painted in aluminium bilayer, black or chrome of 25 mm. Seat and chair back in polyurethane.

ESTRUCTURA FRAMEWORK	CÓDIGO CODE
Pintado en aluminio bicapa, o consultar colores <i>Painted in aluminium bilayer or see colors.</i>	0580L 0580N
Cromado <i>Chrome</i>	0580C

POLIURETANO
POLYURETHANE

127.05

141.75

h96 h73 h47 h40 7,000 1 0,183

Sólo en interiores Indoor

Poliuretano Polyurethane - I



Dalia



0175



Silla con estructura de acero pintada en aluminio bicapa de 15x25 mm. Asiento y respaldo en poliuretano.
Chair with steel structure painted in aluminium bilayer of 15x25 mm. Seat and chair back in polyurethane.

ESTRUCTURA FRAMEWORK	CÓDIGO CODE
Pintado en aluminio bicapa, o consultar colores <i>Painted in aluminium bilayer or see colors.</i>	0175L

184 146 150 42 8,200 2 0,295

Apilable <i>Stackable</i>
Sólo en interiores <i>Indoor</i>

POLIURETANO POLYURETHANE
123.90

Poliuretano *Polyurethane*
U IT IU I3 IN

1175



Sillón con estructura de acero pintada en aluminio bicapa de 15x25 mm. Asiento y respaldo en poliuretano.
Armchair with steel structure painted in aluminium bilayer of 15x25 mm. Seat and chair back in polyurethane.

ESTRUCTURA FRAMEWORK	CÓDIGO CODE
Pintado en aluminio bicapa, o consultar colores <i>Painted in aluminium bilayer or see colors.</i>	1175L

184 146 150 52 9,600 2 0,406

Apilable <i>Stackable</i>
Sólo en interiores <i>Indoor</i>

POLIURETANO POLYURETHANE
144.90

Poliuretano *Polyurethane*
U IT IU I3 IN

0575



Taburete con estructura de acero pintada en aluminio bicapa de 15x25 mm. Asiento y respaldo en poliuretano.
Stool with steel structure painted in aluminium bilayer of 15x25 mm. Seat and chair back in polyurethane.

ESTRUCTURA FRAMEWORK	CÓDIGO CODE
Pintado en aluminio bicapa, o consultar colores <i>Painted in aluminium bilayer or see colors.</i>	0575L

190 175 147 41,5 7,000 1 0,166

Apilable <i>Stackable</i>
Sólo en interiores <i>Indoor</i>

POLIURETANO POLYURETHANE
119.70

Poliuretano *Polyurethane*
U IT IU I3 IN

0576



Taburete con estructura de acero pintado. Asiento de poliuretano.
Stool with steel structure painted. Seat in polyurethane.

ESTRUCTURA FRAMEWORK	CÓDIGO CODE
Pintado en aluminio bicapa, o consultar colores <i>Painted in aluminium bilayer or see colors.</i>	0576L

190 175 138 41,5 7,000 1 0,166

Sólo en interiores <i>Indoor</i>
Sistema Fijo <i>Fixed system</i>

POLIURETANO POLYURETHANE
162.75

Poliuretano *Polyurethane*
U IT IU I3 IN

0211



Silla con estructura de acero pintada en aluminio bicapa o cromado de 20x20 mm. Carcasa en madera lacada o estratificado.
Chair with steel structure painted in aluminium bilayer or chromed of 20x20 mm. Framework in lacquered wood or stratified.

ESTRUCTURA FRAMEWORK	CÓDIGO CODE
Pintado en aluminio bicapa, o consultar colores <i>Painted in aluminium bilayer or see colors.</i>	0211L 02111

188 146 150 46 6,000 3 0,295

Apilable <i>Stackable</i>
Sólo en interiores <i>Indoor</i>

ESTRATIFICADO STRATIFIED
98.70

111.30

Estratificado *Stratified - E*

EB EU EN
EE EO EZ EW

1211



Sillón con estructura de acero pintada en aluminio bicapa o cromado de 20x20 mm. Carcasa en madera lacada o estratificado.
Armchair with steel structure painted in aluminium bilayer or chromed of 20x20 mm. Framework in lacquered wood or stratified.

ESTRUCTURA FRAMEWORK	CÓDIGO CODE
Pintado en aluminio bicapa, o consultar colores <i>Painted in aluminium bilayer or see colors.</i>	1211L 12111

188 145 150 57 7,000 3 0,406

Apilable <i>Stackable</i>
Sólo en interiores <i>Indoor</i>

ESTRATIFICADO STRATIFIED
123.90

135.45

Estratificado *Stratified - E*

EB EU EN
EE EO EZ EW

0519



Taburete con estructura de acero pintada en aluminio bicapa o cromado de 20x20 mm. Carcasa en madera lacada o estratificado.
Stool with steel structure painted in aluminium bilayer or chromed of 20x20 mm. Framework in lacquered wood or stratified.

ESTRUCTURA FRAMEWORK	CÓDIGO CODE
Pintado en aluminio bicapa, o consultar colores <i>Painted in aluminium bilayer or see colors.</i>	0519L 05191

1101 175 150 46 7,000 3 0,406

Apilable <i>Stackable</i>
Sólo en interiores <i>Indoor</i>

ESTRATIFICADO STRATIFIED
135.45

154.35

Estratificado *Stratified - E*

EB EU EN
EE EO EZ EW

0043



Silla con estructura de acero pintada en aluminio bicapa con tubo de 25x15mm. Asiento y respaldo en madera lacada.
Chair with steel structure painted in aluminium bilayer or chromed of 20x20 mm. Framework in lacquered wood or stratified.

ESTRUCTURA FRAMEWORK	CÓDIGO CODE
Pintado en aluminio bicapa, o consultar colores <i>Painted in aluminium bilayer or see colors.</i>	0043L
Cromado <i>Chrome</i>	0043C

H 80 | T 45 | H 42 | H 45 | Pkg 6,390 | 2 | 0,185

Sólo en interiores *Indoor*

ESTRATIFICADO
STRATIFIED

72.45

81.90

Estratificado *Stratified - E*

EB EU EN

EE EO EZ EW

0480



Taburete con estructura de acero pintada en aluminio bicapa con tubo de 25x15mm. Asiento y respaldo en madera lacada.
Stool with steel structure painted in aluminium bilayer or chromed of 20x20 mm. Framework in lacquered wood or stratified.

ESTRUCTURA FRAMEWORK	CÓDIGO CODE
Pintado en aluminio bicapa, o consultar colores <i>Painted in aluminium bilayer or see colors.</i>	0480L

T 47 | T 30x30 | Pkg 2,200 | 2 | 0,127

Apilable *Stackable*

Sólo en interiores *Indoor*

ESTRATIFICADO
STRATIFIED

49.00

Estratificado *Stratified - E*

EB EU EN

EE EO EZ EW



0570



Taburete con estructura de acero pintada en aluminio bicapa con tubo de 25x15mm. Asiento y respaldo en madera lacada.
Stool with steel structure painted in aluminium bilayer or chromed of 20x20 mm. Framework in lacquered wood or stratified.

ESTRUCTURA FRAMEWORK	CÓDIGO CODE
Pintado en aluminio bicapa, o consultar colores <i>Painted in aluminium bilayer or see colors.</i>	0570L

H 100 | T 76 | H 40 | H 36 | Pkg 6,75 | 2 | 0,127

Sólo en interiores *Indoor*

ESTRATIFICADO
STRATIFIED

101.85

Estratificado *Stratified - E*

EB EU EN

EE EO EZ EW

0208



Silla con estructura de acero pintada en aluminio bicapa o cromado con tubo de 20x20 mm. Carcasa en estratificado.
Chair with steel structure painted in aluminium bilayer or chromed with pipe of 20x20 mm. Framework in stratified.

ESTRUCTURA FRAMEWORK	CÓDIGO CODE
Pintado en aluminio bicapa, o consultar colores <i>Painted in aluminium bilayer or see colors.</i>	0208L
Cromado <i>Chrome</i>	0208C

H 82 | T 47 | H 45,6 | H 43 | Pkg 5,700 | 3 | 0,220

Apilable *Stackable*

Sólo en interiores *Indoor*

ESTRATIFICADO
STRATIFIED

91.35

108.15

Estratificado *Stratified - E*

EB EU EN

EE EO EZ EW

0571



Taburete con estructura de acero pintada en aluminio bicapa con tubo de 25x15mm. Asiento y respaldo en madera lacada.
Stool with steel structure painted in aluminium bilayer or chromed of 20x20 mm. Framework in lacquered wood or stratified.

ESTRUCTURA FRAMEWORK	CÓDIGO CODE
Pintado en aluminio bicapa, o consultar colores <i>Painted in aluminium bilayer or see colors.</i>	0571L
Cromado <i>Chrome</i>	0571C

H 99 | T 76 | H 37 | H 35 | Pkg 6,860 | 1 | 0,183

Sólo en interiores *Indoor*

ESTRATIFICADO
STRATIFIED

103.95

121.80

Estratificado *Stratified - E*

EB EU EN

EE EO EZ EW

0226

Silla con estructura de acero pintada en aluminio bicapa o cromado con tubo de 25x15 mm. Asiento y respaldo en madera lacada, compacto o estratificado.
Chair with steel structure painted in aluminium bilayer or chromed with pipe of 25x15 mm. Seat and chair back in lacquered wood, compact or stratified.



ESTRUCTURA FRAMEWORK	CÓDIGO CODE
Pintado en aluminio bicapa, o consultar colores <i>Painted in aluminium bilayer or see colors.</i>	0226L 02261
Cromado <i>Chrome</i>	0226C

H 82 | W 47 | D 36 | H 40 | P 6,850 | 1 | 0,220

Interores/cubierto *Indoor/cover*

ESTRATIFICADO STRATIFIED	COMPACTO COMPACT
71.45	78.75
82.95	89.25

Estratificado *Stratified - E*

EB EU EN

EE EO EZ EW

Compacto *Compact - C*

CB C6 CK CJ CT CU C3 CA CN

CW CO CE

0526

Taburete con estructura de acero pintada en aluminio bicapa o cromado con tubo de 25 mm. Asiento y respaldo en madera lacada, compacto o estratificado.
Armchair with steel structure painted in aluminium bilayer or chromed with pipe of 25 mm. Seat and chair back in lacquered wood, compact or stratified.



ESTRUCTURA FRAMEWORK	CÓDIGO CODE
Pintado en aluminio bicapa, o consultar colores <i>Painted in aluminium bilayer or see colors.</i>	0526L 05261
Cromado <i>Chrome</i>	0526C

H 53 | W 46 | D 35 | H 35 | P 4,915 | 1 | 0,127

Interores/cubierto *Indoor/cover*

ESTRATIFICADO STRATIFIED	COMPACTO COMPACT
73.50	77.70
81.90	88.20

Estratificado *Stratified - E*

EB EU EN

EE EO EZ EW

Compacto *Compact - C*

CB C6 CK CJ CT CU C3 CA CN

CW CO CE

0596

Taburete con estructura de acero pintada en aluminio bicapa o cromado con tubo de 25 mm. Asiento y respaldo en madera lacada, compacto o estratificado.
Armchair with steel structure painted in aluminium bilayer or chromed with pipe of 25 mm. Seat and chair back in lacquered wood, compact or stratified.



ESTRUCTURA FRAMEWORK	CÓDIGO CODE
Pintado en aluminio bicapa, o consultar colores <i>Painted in aluminium bilayer or see colors.</i>	0596L 05961
Cromado <i>Chrome</i>	0596C

H 85 | W 77 | D 37 | H 37 | P 6,99 | 1 | 0,166

Interores/cubierto *Indoor/cover*

ESTRATIFICADO STRATIFIED	COMPACTO COMPACT
76.65	82.95
86.10	95.55

Estratificado *Stratified - E*

EB EU EN

EE EO EZ EW

Compacto *Compact - C*

CB C6 CK CJ CT CU C3 CA CN

CW CO CE

0203

Silla con estructura de acero pintada en aluminio bicapa con tubo de 20x20mm. Asiento compacto.
Chair with steel structure painted in aluminium bilayer with pipe of 20x20mm. Seat in compact.



ESTRUCTURA FRAMEWORK	CÓDIGO CODE
Pintado en aluminio bicapa, o consultar colores <i>Painted in aluminium bilayer or see colors.</i>	0203L 02031

H 82 | W 46 | D 40 | H 43 | P 6,00 | 3 | 0,220

Apilable *Stackable*

Útil para exteriores *Outdoor*

COMPACTO COMPACT
71.40

Compacto *Compact - C*

CB C6 CK CJ CT CU C3 CA CN

CW CO CE

0577

Taburete con estructura de acero pintada en aluminio bicapa con tubo de 20x20mm. Asiento compacto.
Stool with steel structure painted in aluminium bilayer with pipe of 20x20mm. Seat in compact.



ESTRUCTURA FRAMEWORK	CÓDIGO CODE
Pintado en aluminio bicapa, o consultar colores <i>Painted in aluminium bilayer or see colors.</i>	0577L 05771

H 99 | W 76 | D 37 | H 35 | P 6,370 | 3 | 0,220

Útil para exteriores *Outdoor*

COMPACTO COMPACT
86.10

Compacto *Compact - C*

CB C6 CK CJ CT CU C3 CA CN

CW CO CE

0202

Silla estructura de madera y refuerzo de acero. Carcasa de estratificado en diferentes acabados. Asiento polipiel.
Chair structure made of wood and steel reinforcement. backrest in stratified. Seat in imitation leather.



ESTRUCTURA FRAMEWORK	CÓDIGO CODE
Estructura en nogal o wengué <i>Structure in walnut or wenge</i>	0202M

H 71 | W 46 | D 45 | H 52 | P 9,100 | 1 | 0,815

Sólo en interiores *Indoor*

ESTRATIFICADO STRATIFIED
194.25

Estratificado *Stratified - E*

EB EU EN

EE EO EZ EW

Polipiel *Imitation Leather - L*

LB LN LK LQ

0199

Silla con estructura de acero y pie de madera. Carcasa de estratificado en diferentes acabados o polipropileno.
 Chair with steel structure and wooden foot. Seat and back in stratified or polypropylene.

ESTRUCTURA FRAMEWORK	CÓDIGO CODE	ESTRATIFICADO ESTRATIFIED
Estructura en nogal o wengué Structure in walnut or wenge	0199M	116.96

Estratificado Stratified - E

EB EU EN EE EO EW

h71 h46 h45 h52 9,100 1 0,815

Sólo en interiores Indoor



0201

Silla con estructura de acero y pie de madera. Carcasa de polipropileno.
Chair with steel structure and wooden foot. Seat and back polypropylene.



ESTRUCTURA FRAMEWORK	CÓDIGO CODE
Estructura en nogal o wengué Structure in walnut or wenge	0201M

POLIPROPILENO POLYPROPYLENE
74.80

Polipropileno Polypropylene - R

RB RK RJ RT RU R3 RN

h 82 h 48 h 38 h 49,5	kg 5,43	📦 -	📦 -
-----------------------------	---------	-----	-----

🏠 Sólo en interiores Indoor



0145

Silla con estructura de acero pintada en aluminio bicapa o cromado con tubo de 20x20 mm. Carcasa en estratificado.
Chair with steel structure painted aluminium bilayer or chromed with pipe of 20x20 mm. Framework in stratified.



ESTRUCTURA FRAMEWORK	CÓDIGO CODE
Pintado en aluminio bicapa, o consultar colores Painted in aluminium bilayer or see colors.	0145L
Cromado Chrome	0145C

h 88 h 46 h 54 h 46	kg 6,000	📦 2	📦 0,165
---------------------------	----------	-----	---------

📦 Apilable Stackable

🏠 Sólo en interiores Indoor

ESTRATIFICADO STRATIFIED
102.90
115.50

Estratificado Stratified - E

EB EU EN

EE EO EZ EW

0207

Silla con estructura de acero pintada en aluminio bicapa o cromado con tubo de 20x20 mm. Carcasa en estratificado.
Chair with steel structure painted aluminium bilayer or chromed with pipe of 20x20 mm. Framework in stratified.



ESTRUCTURA FRAMEWORK	CÓDIGO CODE
Pintado en aluminio bicapa, o consultar colores Painted in aluminium bilayer or see colors.	0207L
Cromado Chrome	0207C

h 90 h 46 h 46 h 38	kg 4,700	📦 4	📦 0,339
---------------------------	----------	-----	---------

📦 Apilable Stackable

🏠 Sólo en interiores Indoor

ESTRATIFICADO STRATIFIED
88.00
88.00

Estratificado Stratified - E

EB EU EN

EE EO EZ EW

0210

Silla con estructura de acero pintada en aluminio bicapa o cromado con tubo de 20x20 mm. Carcasa en estratificado.
Chair with steel structure painted aluminium bilayer or chromed with pipe of 20x20 mm. Framework in stratified.



ESTRUCTURA FRAMEWORK	CÓDIGO CODE
Pintado en aluminio bicapa, o consultar colores Painted in aluminium bilayer or see colors.	0210L
Cromado Chrome	0210C

h 87 h 45 h 49 h 46	kg 5,840	📦 4	📦 0,358
---------------------------	----------	-----	---------

📦 Apilable Stackable

🏠 Sólo en interiores Indoor

ESTRATIFICADO STRATIFIED
98.70
111.30

Estratificado Stratified - E

EB EU EN

EE EO EZ EW



0072

Silla con estructura de acero con patas conificadas y pintadas según acabado ABS o cromado con tubo de 30 mm. Asiento y respaldo en ABS.
Chair with steel structure, conical legs and painted according to finished ABS or chromed with pipe of 30 mm. Seat and chair back in ABS.

ASIENTO Y RESPALDO
ABS



ESTRUCTURA FRAMEWORK	CÓDIGO CODE
Acero pintado según acabado ABS <i>Steel painted with ABS finished</i>	0072
Cromado <i>Chrome</i>	0072C

h79 h47 h48 H42 4,170 2 0,222

Interiores/cubierto *Indoor/cover*

ABS LISOS SMOOTH ABS	ABS MADERA WOOD ABS
59.85	70.35
72.45	84.00

ABS Lisos *Smooth ABS*

ABS Madera *Wood ABS - G*

0074

Sillón con estructura de acero con patas conificadas y pintadas según acabado ABS o cromado con tubo de 30 mm. Asiento y respaldo en ABS.
Armchair with steel structure, conical legs and painted according to finished ABS or chromed with pipe of 30 mm. Seat and chair back in ABS.



ESTRUCTURA FRAMEWORK	CÓDIGO CODE
Acero pintado según acabado ABS <i>Steel painted with ABS finished</i>	0074
Cromado <i>Chrome</i>	0074C

h79 h47 h48 H45 5,100 2 0,284

Interiores/cubierto *Indoor/cover*

ABS LISOS SMOOTH ABS	ABS MADERA WOOD ABS
66.15	77.70
80.85	92.40

ABS Lisos *Smooth ABS*

ABS Madera *Wood ABS - G*

0554

Taburete con estructura de acero con patas conificadas y pintadas según acabado ABS o cromado con tubo de 30 mm. Asiento y respaldo en ABS.
Stool with steel structure, conical legs and painted according to finished ABS or chromed with pipe of 30 mm. Seat and chair back in ABS.



ESTRUCTURA FRAMEWORK	CÓDIGO CODE
Acero pintado según acabado ABS <i>Steel painted with ABS finished</i>	0554
Cromado <i>Chrome</i>	0554C

h104 h75 h48 H55 4,800 1 0,218

Interiores/cubierto *Indoor/cover*

ABS LISOS SMOOTH ABS	ABS MADERA WOOD ABS
72.45	84.00
85.05	96.60

ABS Lisos *Smooth ABS*

ABS Madera *Wood ABS - G*

0230



Silla con estructura de acero termolacado en pintura de poliéster. Tubo de 28 ø. Asiento de compacto en los diferentes acabados según tarifa.
 Chair with steel structure thermo-lacquered in polyester paint. Tube of 28 ø. Compact seat in the different finishes according to catalog.

ESTRUCTURA FRAMEWORK	CÓDIGO CODE
Pintado en aluminio bicapa, o consultar colores <i>Painted in aluminium bilayer or see colors.</i>	0230L

h71 h46 h45 h52 8,520 1 0,815

Sólo en interiores *Indoor*

COMPACTO COMPACT
44.10

Compacto Compact - C

CB C6 CK CJ CT CU C3 CA CN

CW CO CE

0151



Silla con estructura de acero pintada en marrón o negro con tubo de 22 mm. Asiento en ABS.
 Chair with steel structure painted in brown or black with tube of 22 mm. Seat in ABS.

ESTRUCTURA FRAMEWORK	CÓDIGO CODE
Marrón o Negro <i>Brown or Black</i>	0151

h85 h46 h48 h39 4,500 2 0,238

Sólo en interiores *Indoor*

ABS LISOS SMOOTH ABS
47.25

ABS Lisos Smooth ABS

GN GQ

1150



Silla con estructura de acero pintada en aluminio bicapa, blanco, negro o cromo con tubo de 22 mm. Asiento de poliuretano o polipiel.
 Chair with steel structure painted in aluminium bilayer, white, black or chromed with pipe of 22 mm. Seat in polyurethane or imitation leather.

ESTRUCTURA FRAMEWORK	CÓDIGO CODE
Pintado en aluminio bicapa, o consultar colores <i>Painted in aluminium bilayer or see colors.</i>	1150L 1150B 1150N
Cromado <i>Chrome</i>	1150C

Sólo en interiores *Indoor*

POLIURETANO POLYURETHANE	POLIPIEL IMITATION LEATHER
59.85	66.15
72.45	78.75

Poliuretano Polyurethane - I

U IT IU I3 IN

Polipiel Imitation Leather - L

LB LJ LT LU L3 LV LA LN

1153



Silla con estructura de acero pintada en aluminio bicapa, blanco, negro o cromo con tubo de 22 mm. Asiento en polipiel.
 Chair with steel structure painted in aluminium bilayer, white, black or chromed with pipe of 22 mm. Imitation leather seat.

ESTRUCTURA FRAMEWORK	CÓDIGO CODE
Pintado en aluminio bicapa, o consultar colores <i>Painted in aluminium bilayer or see colors.</i>	1153L 1153B 1153N
Cromado <i>Chrome</i>	1153C

h85 h44 h45 h40 5,500 2 0,193

Sólo en interiores *Indoor*

POLIPIEL IMITATION LEATHER
66.15
78.75

Polipiel Imitation Leather - L

LB LJ LT LU L3 LV LA LN

0551



Taburete con estructura de acero pintada en aluminio bicapa o cromo con tubo de 22 mm. Asiento de poliuretano, compacto o polipiel.
 Stool with steel structure painted in aluminium bilayer or chromed with pipe of 22 mm. Seat in polyurethane, compact or imitation leather.

ESTRUCTURA FRAMEWORK	CÓDIGO CODE
Pintado en aluminio bicapa, o consultar colores <i>Painted in aluminium bilayer or see colors.</i>	0551L 0551B 0551N
Cromado <i>Chrome</i>	0551C

T45 T36X36 3,700 2 0,092

Interiores/cubierto *Indoor/cover*

Poliuretano Polyurethane - I

U IT IU IA IN

Compacto Compact - C

CB C6 CK CJ CT CU C3 CA CN

CW CO CE

COMPACTO COMPACT	POLIURETANO POLYURETHANE	POLIPIEL IMITATION LEATHER
61.95	61.95	61.95
72.45	72.45	72.45

0552



Taburete con estructura de acero pintada en aluminio bicapa o cromo con tubo de 22 mm. Asiento de poliuretano, compacto o polipiel.
 Stool with steel structure painted in aluminium bilayer or chromed with pipe of 22 mm. Seat in polyurethane, compact or imitation leather.

ESTRUCTURA FRAMEWORK	CÓDIGO CODE
Pintado en aluminio bicapa, o consultar colores <i>Painted in aluminium bilayer or see colors.</i>	0552L 0552B 0552N
Cromado <i>Chrome</i>	0552C

h96 h72 h42 h36 6,900 1 0,147

Interiores/cubierto *Indoor/cover*

Poliuretano Polyurethane - I

U IT IU IA IN

Compacto Compact - C

CB C6 CK CJ CT CU C3 CA CN

CW CO CE

COMPACTO COMPACT	POLIURETANO POLYURETHANE	POLIPIEL IMITATION LEATHER
80.85	80.85	80.85
93.45	93.45	93.45

0550



Taburete con estructura de acero pintada en aluminio bicapa o cromo con tubo de 22 mm. Asiento de poliuretano, compacto o polipiel.
 Stool with steel structure painted in aluminium bilayer or chromed with pipe of 22 mm. Seat in polyurethane, compact or imitation leather.

ESTRUCTURA FRAMEWORK	CÓDIGO CODE
Pintado en aluminio bicapa, o consultar colores <i>Painted in aluminium bilayer or see colors.</i>	0550L 0550B 0550N
Cromado <i>Chrome</i>	0550C

T72 T36X36 3,700 2 0,092

Poliuretano Polyurethane - I

U IT IU IA IN

Compacto Compact - C

CB C6 CK CJ CT CU C3 CA CN

CW CO CE

COMPACTO COMPACT	POLIURETANO POLYURETHANE	POLIPIEL IMITATION LEATHER
63.00	63.00	63.00
74.55	74.55	63.00

0140

Sillón con estructura de acero pintada en aluminio bicapa o cromo con tubo de 25 mm. Asiento y respaldo en médula de polipropileno imitación rattan.
Armchair with steel structure painted in aluminium bilayer or chromed with pipe of 25 mm. Seat and chair back in polypropylene spinal rattan imitation.



ESTRUCTURA FRAMEWORK	CÓDIGO CODE
Pintado aluminio bicapa. Consultar colores Painted in aluminium bilayer or see colors.	0140L
Acero Cromado Chromed Steel	0140C

POLIPROPILENO POLYPROPYLENE
45.36
55.86

H71 H42 H53 H57 4,600 12 0,772

Polipropileno Polypropylene - R

RB RK RJ RU R3 RN RA

Apilable Stackable
 Útil para exteriores Outdoor

0149

Sillón con estructura de acero pintada en aluminio bicapa o cromo con tubo de 25 mm. Asiento y respaldo en médula de polipropileno imitación rattan.
Armchair with steel structure painted in aluminium bilayer or chromed with pipe of 25 mm. Seat and chair back in polypropylene spinal rattan imitation.



ESTRUCTURA FRAMEWORK	CÓDIGO CODE
Pintado aluminio bicapa. Consultar colores Painted in aluminium bilayer or see colors.	0149L
Acero Cromado Chromed Steel	0149C

POLIPROPILENO POLYPROPYLENE
48.30
59.85

H81 H42 H57 H54 3,700 12 0,781

Polipropileno Polypropylene - R

RB RK RJ RU R3 RN RA

Apilable Stackable
 Útil para exteriores Outdoor

1140

Sillón con estructura de acero pintada en aluminio bicapa o cromo con tubo de 25 mm. Asiento y respaldo en polipiel.
Armchair with steel structure painted in aluminium bilayer or chromed, with pipe of 25 mm. Seat and chair back in imitation leather.



ESTRUCTURA FRAMEWORK	CÓDIGO CODE
Pintado aluminio bicapa. Consultar colores Painted in aluminium bilayer or see colors.	1140L
Acero Cromado Chromed Steel	1140C

POLIPIEL IMITATION LEATHER
89.25
103.95

H82 H44 H57 H54 7,400 2 0,280

Polipiel Imitation Leather - L

LB LU L3 LA LN

Apilable Stackable
 Sólo en interiores Indoor

1190

Sillón con estructura de acero pintada en aluminio bicapa o cromo con tubo de 25 mm. Asiento y respaldo en polipiel.
Armchair with steel structure painted in aluminium bilayer or chrome with tube of 25 mm. Seat and chair back in imitation leather.



ESTRUCTURA FRAMEWORK	CÓDIGO CODE
Pintado en aluminio bicapa, o consultar colores Painted in aluminium bilayer or see colors.	1190L
Acero Cromado Chromed Steel	1190C

POLIPIEL IMITATION LEATHER
90.30
103.95

H84 H45 H54 H52 7,500 2 0,280

Polipiel Imitation Leather - L

LB LU L3 LA LN

Apilable Stackable
 Sólo en interiores Indoor

1192

Silla con estructura de acero pintada en aluminio bicapa o cromo con tubo de 25 mm. Asiento y respaldo en polipiel.
Chair with steel structure painted in aluminium bilayer or chrome with pipe of 25 mm. Seat and chair back in polyskin.



ESTRUCTURA FRAMEWORK	CÓDIGO CODE
Pintado en aluminio bicapa, o consultar colores Painted in aluminium bilayer or see colors.	1192L
Acero Cromado Chromed Steel	1192C

POLIPIEL IMITATION LEATHER
95.55
109.20

H79 H43 H53 H54 6,400 2 0,290

Polipiel Imitation Leather - L

LB LU L3 LA LN

Apilable Stackable
 Sólo en interiores Indoor

1194

Silla con estructura de acero pintada en aluminio bicapa o cromo con tubo de 25 mm. Asiento y respaldo en polipiel.
Chair with steel structure painted in aluminium bilayer or chrome with pipe of 25 mm. Seat and chair back in polyskin.



ESTRUCTURA FRAMEWORK	CÓDIGO CODE
Pintado en aluminio bicapa, o consultar colores Painted in aluminium bilayer or see colors.	1194L
Acero Cromado Chromed Steel	1194C

POLIPIEL IMITATION LEATHER
86.10
97.65

H82 H44 H57 H54 7,400 2 0,280

Polipiel Imitation Leather - L

LB LU L3 LA LN

Apilable Stackable
 Sólo en interiores Indoor

1195

Silla con estructura de acero pintada en aluminio bicapa o cromo en tubo ovalado. Asiento y respaldo en polipiel.
Chair with steel structure painted in aluminium bilayer or chrome in oval pipe of. Seat and chair back in polyskin.



ESTRUCTURA FRAMEWORK	CÓDIGO CODE
Pintado en aluminio bicapa, o consultar colores Painted in aluminium bilayer or see colors.	1195L
Acero Cromado Chromed Steel	1195C

POLIPIEL IMITATION LEATHER
80.85
93.45

H84 H45 H48 H53 7,000 2 0,260

Polipiel Imitation Leather - L

LB LU L3 LA LN

Apilable Stackable
 Sólo en interiores Indoor

0561



Taburete con estructura de acero pintada en aluminio bicapa o cromo de 25 mm. Asiento en polipropileno.
 Stool with steel structure painted in aluminium bilayer or chrome of 25 mm. Seat in polypropylene.

ESTRUCTURA FRAMEWORK	CÓDIGO CODE
Pintado en aluminio bicapa, o consultar colores <i>Painted in aluminium bilayer or see colors.</i>	0561L
Acero Cromado <i>Chromed Steel</i>	0561C

POLIPROPILENO POLYPROPYLENE
74.85
86.10

H 100 | h 76 | h 45 | H 42 | P 6,840 | 2 | 0,092

Sólo en interiores *Indoor*

Polipropileno *Polypropylene - V*
 El color tiene una codificación diferente porque no corresponde con el resto del material.

VU VA VN

0594



Taburete con estructura de acero pintada en aluminio bicapa o cromo. Asiento en Estratificado.
 Stool with steel structure painted in aluminium bilayer or chrome. Seat in stratified.

ESTRUCTURA FRAMEWORK	CÓDIGO CODE
Cromado <i>Chrome</i>	0594C

ESTRATIFICADO STRATIFIED
115.50

H 85 | h 74 | h 38 | H 41 | P 12,50 | 1 | 0,170

Sólo en interiores *Indoor*

Sistema Fijo *Fixed system*

Estratificado *Stratified - E*

EB EU EN
 EE EO EZ EW

0599



Taburete en estructura de acero cromado. Asiento en estratificado o compacto.
 Stool in chrome steel structure. Revolving. Seat in stratified or compact.

ESTRUCTURA FRAMEWORK	CÓDIGO CODE
Pintado en aluminio bicapa, o consultar colores <i>Painted in aluminium bilayer or see colors.</i>	0599L
Cromado <i>Chrome</i>	0599C

MADERA WOOD	COMPACTO COMPACT	ESTRATIFICADO STRATIFIED
115.50	110.00	110.00
126.00	120.00	120.00

H 87 | h 74 | h 41 | H 41 | P 15,97 | 1 | 0,170

Compacto *Compact - C*

CB C6 CK CJ CT CU C3 CA CN
 CW CO CE

Sólo en interiores *Indoor*

Sistema Fijo *Fixed system*

Estratificado *Stratified - E*

EB EU EN
 EE EO EZ EW

0593



Taburete en estructura de acero cromado. Asiento en estratificado o compacto.
 Stool in chrome steel structure. Revolving. Seat in stratified or compact.

ESTRUCTURA FRAMEWORK	CÓDIGO CODE
Pintado en aluminio bicapa, o consultar colores <i>Painted in aluminium bilayer or see colors.</i>	0593L
Cromado <i>Chrome</i>	0593C

MADERA WOOD	COMPACTO COMPACT	ESTRATIFICADO STRATIFIED
124.95	124.95	124.95
135.45	135.45	135.45

H 87 | h 74 | h 41 | H 41 | P 15,97 | 1 | 0,170

Compacto *Compact - C*

CB C6 CK CJ CT CU C3 CA CN
 CW CO CE

Sólo en interiores *Indoor*

Sistema Giratorio *Revolving*

Estratificado *Stratified - E*

EB EU EN
 EE EO EZ EW



0597 - 0595



Taburete con estructura de acero cromado. Asiento en madera o estratificado.
Stool with chrome steel structure. Seat in wood or stratified.

Sistema Fijo Fixed system

ESTRUCTURA FRAMEWORK	CÓDIGO CODE	MADERA WOOD	ESTRATIFICADO STRATIFIED
Pintado en aluminio bicapa, o consultar colores <i>Painted in aluminium bilayer or see colors.</i>	0597L	154.35	154.35
Cromado <i>Chrome</i>	0597C	164.85	164.85

h 97 h 74 h 41 h 41 16,30 1 0,170

Sólo en interiores Indoor

Sistema Giratorio Revolving

ESTRUCTURA FRAMEWORK	CÓDIGO CODE	MADERA WOOD	ESTRATIFICADO STRATIFIED
Pintado en aluminio bicapa, o consultar colores <i>Painted in aluminium bilayer or see colors.</i>	0595L	177.45	177.45
Cromado <i>Chrome</i>	0595C	187.95	187.95

h 97 h 74 h 41 h 41 16,30 1 0,170

Sólo en interiores Indoor

Estratificado Stratified - E

EB	EU	EN
EE	EO	EZ
EW		

0543



Taburete con estructura de acero pintada en aluminio bicapa, marrón, negro, haya, cerezo o nogal con tubo de 22 mm. Asiento en rejilla metálica.
Stool with steel structure painted in aluminium bilayer, brown, black, beech, cherry-tree or walnut with tube of 22 mm. Seat in metallic grid.

ESTRUCTURA FRAMEWORK	CÓDIGO CODE	REJILLA WICKER
Marrón, Negro, Haya, Cerezo o Nogal <i>Brown, Black, Beech, Cherry or Walnut</i>	0543	49.35
Bicapa aluminizado <i>Bi-coat aluminized</i>	0543L	49.35

T 75 T 35X35 4,150 2 0,133

Interiores/cubierto Indoor/cover

0573



Taburete con estructura de acero pintada en aluminio bicapa con tubo de 22 mm. Asiento en compacto.
Stool with steel structure, painted in aluminium bilayer with pipe of 22 mm. Seat in compact.

ESTRUCTURA FRAMEWORK	CÓDIGO CODE	COMPACTO COMPACT
Pintado en aluminio bicapa, o consultar colores <i>Painted in aluminium bilayer or see colors.</i>	0573L	63.00
Cromado <i>Chrome</i>	0573C	75.60

Sólo en interiores Indoor

T 76 T 39 5,00 1 0,120

Compacto Compact - C

CB	C6	CK	CJ	CT	CU	C3	CA	CN	CG	CW	CO	CE
----	----	----	----	----	----	----	----	----	----	----	----	----

0553



Taburete con estructura de acero pintada en aluminio bicapa, marrón, negro, haya, cerezo o nogal con tubo de 22 mm. Asiento en rejilla metálica.
Stool with steel structure painted in aluminium bilayer, brown, black, beech, cherry-tree or walnut with tube of 22 mm. Seat in metallic grid.

ESTRUCTURA FRAMEWORK	CÓDIGO CODE	REJILLA WICKER
Marrón, Negro, Haya, Cerezo o Nogal <i>Brown, Black, Beech, Cherry or Walnut</i>	0553	63.00
Bicapa aluminizado <i>Bi-coat aluminized</i>	0553L	63.00

h 96 h 75 h 42 h 36 4,650 1 0,145

Interiores/cubierto Indoor/cover

Compacto Compact - C

CB	C6	CK	CJ	CT	CU	C3	CA	CN	CG	CW	CO	CE
----	----	----	----	----	----	----	----	----	----	----	----	----

0521



Taburete con estructura de acero pintada en aluminio bicapa con tubo de 22 mm. Asiento en compacto.
Stool with steel structure, painted in aluminium bilayer with pipe of 22 mm. Seat in compact.

ESTRUCTURA FRAMEWORK	CÓDIGO CODE	COMPACTO COMPACT	MADERA WOOD
Pintado en aluminio bicapa, o consultar colores <i>Painted in aluminium bilayer or see colors.</i>	0521L	76.02	76.02

T 73 T 35X35 5,730 1 0,288

Sólo en interiores Indoor

Útil para exteriores Outdoor

Madera Pino - M Wood - M

MP

Compacto Compact - C

CB	C6	CK	CJ	CT	CU	C3	CA	CN	CG	CW	CO	CE
----	----	----	----	----	----	----	----	----	----	----	----	----

0522



Taburete con estructura de acero pintada en aluminio bicapa con tubo de 22 mm. Asiento en compacto.
Stool with steel structure, painted in aluminium bilayer with pipe of 22 mm. Seat in compact.

ESTRUCTURA FRAMEWORK	CÓDIGO CODE	COMPACTO COMPACT
Pintado en aluminio bicapa, o consultar colores <i>Painted in aluminium bilayer or see colors.</i>	0522L	53.05
Cromado <i>Chrome</i>	0522C	64.93

T 76 T 34X31 5,730 1 0,288

Sólo en interiores Indoor

Útil para exteriores Outdoor

Compacto Compact - C

CB	C6	CK	CJ	CT	CU	C3	CA	CN	CG	CW	CO	CE
----	----	----	----	----	----	----	----	----	----	----	----	----

0523



Taburete con estructura de acero pintada en aluminio bicapa con tubo de 22 mm. Asiento en compacto.
 Stool with steel structure, painted in aluminium bilayer with pipe of 22 mm. Seat in compact.

ESTRUCTURA FRAMEWORK	CÓDIGO CODE	COMPACTO COMPACT
Pintado en aluminio bicapa, o consultar colores <i>Painted in aluminium bilayer or see colors.</i>	0523L	82.95
Cromado <i>Chrome</i>	0523C	95.55

h 87 h 75 h 50 h 47 5,730 1 0,288

Sólo en interiores *Indoor*
 Útil para exteriores *Outdoor*

Compacto *Compact - C*



0510



Taburete con estructura de acero pintada en aluminio bicapa con tubo de 22 mm. Asiento en compacto.
 Stool with steel structure, painted in aluminium bilayer with pipe of 22 mm. Seat in compact.

ESTRUCTURA FRAMEWORK	CÓDIGO CODE	COMPACTO COMPACT
Pintado en aluminio bicapa, o consultar colores <i>Painted in aluminium bilayer or see colors.</i>	0510L	134.40

h 98 h 72 h 35 h 35 6,150 1 0,166

Sólo en interiores *Indoor*
 Útil para exteriores *Outdoor*

Compacto *Compact - C*



BANCADAS

BENCHES



5180

Bancada con estructura de acero pintada en aluminio bicapa . Asiento y respaldo en polipropileno.
Bench with steel structure, painted in aluminium bilayer. Seat and chair back in polypropylene.



h 85 w 46 d 51	15,00	1	1,918
h 85 w 46 d 51	20,00	1	1,699
h 85 w 46 d 51	25,00	1	3,734

Útil para exteriores Outdoor



MODELO MODEL	ESTRUCTURA FRAMEWORK	TIPO PATA LEGS	CÓDIGO CODE	POLIPROPILENO POLYPROPYLENE
118	Pintado en aluminio bicapa, o consultar colores. <i>Painted in aluminium bilayer or see colors.</i>		5520L180	239.40
		5720L180	235.20	
175	Pintado en aluminio bicapa, o consultar colores. <i>Painted in aluminium bilayer or see colors.</i>		5530L180	321.30
		5730L180	317.10	
175	Pintado en aluminio bicapa, o consultar colores. <i>Painted in aluminium bilayer or see colors.</i>		5521L180	302.40
		5721L180	298.20	
225	Pintado en aluminio bicapa, o consultar colores. <i>Painted in aluminium bilayer or see colors.</i>		5540L180	396.90
		5740L180	394.80	
225	Pintado en aluminio bicapa, o consultar colores. <i>Painted in aluminium bilayer or see colors.</i>		5531L180	378.00
		5731L180	375.90	

Polipropileno Polypropylene - R



NOTA: La mesa de las bancada es siempre en compacto
NOTE: The table of the bench its always in compact.

5207 - 5211

Bancada con estructura de acero pintada en aluminio bicapa . Carcasa de madera o estratificada.
Bench with steel structure painted in aluminium bilayer. Framework in wood or stratified.



h 88 w 47 d 42	15,00	1	1,962
h 88 w 47 d 42	20,00	1	2,953
h 88 w 47 d 42	25,00	1	3,821

Sólo en interiores Indoor



MODELO MODEL	ESTRUCTURA FRAMEWORK	TIPO PATA LEGS	CÓDIGO 5211 CODE	CÓDIGO 5207 CODE	ESTRATIFICADO STRATIFIED
113	Pintado en aluminio bicapa, o consultar colores. <i>Painted in aluminium bilayer or see colors.</i>		5520L211	5520L207	253.05
		5720L211	5720L207	247.80	
170	Pintado en aluminio bicapa, o consultar colores. <i>Painted in aluminium bilayer or see colors.</i>		5530L211	5530L207	340.20
		5730L211	5730L207	337.05	
170	Pintado en aluminio bicapa, o consultar colores. <i>Painted in aluminium bilayer or see colors.</i>		5521L211	5521L207	321.30
		5721L211	5721L207	319.20	
220	Pintado en aluminio bicapa, o consultar colores. <i>Painted in aluminium bilayer or see colors.</i>		5540L211	5540L207	423.15
		5740L211	5740L207	420.00	
220	Pintado en aluminio bicapa, o consultar colores. <i>Painted in aluminium bilayer or see colors.</i>		5531L211	5531L207	404.25
		5731L211	5731L207	403.20	

Estratificado Stratified - E



5216

Bancada con estructura de acero pintada en aluminio bicapa . Asiento y respaldo en polipropileno.
Bench with steel structure, painted in aluminium bilayer. Seat and chair back in polypropylene.



h82 w46 d45	15,00	1	1,918
h82 w46 d45	20,00	1	1,699
h82 w46 d45	25,00	1	3,734

Útil para exteriores Outdoor



NIVELADORES NIVELADORES

MODELO MODEL	ESTRUCTURA FRAMEWORK	TIPO PATA LEGS	CÓDIGO CODE	POLIPROPILENO POLYPROPYLENE
113	Pintado en aluminio bicapa, o consultar colores. <i>Painted in aluminium bilayer or see colors.</i>		5520L216	198.45
		5720L216	193.20	
170	Pintado en aluminio bicapa, o consultar colores. <i>Painted in aluminium bilayer or see colors.</i>		5530L216	258.30
		5730L216	255.15	
170	Pintado en aluminio bicapa, o consultar colores. <i>Painted in aluminium bilayer or see colors.</i>		5521L216	239.40
		5721L216	236.25	
220	Pintado en aluminio bicapa, o consultar colores. <i>Painted in aluminium bilayer or see colors.</i>		5540L216	31290
		5740L216	310.80	
220	Pintado en aluminio bicapa, o consultar colores. <i>Painted in aluminium bilayer or see colors.</i>		5531L216	294.00
		5731L216	291.90	

Polipropileno Polypropylene · R



NOTA: La mesa de las bancada es siempre en compacto
NOTE: The table of the bench its always in compact.

5575

Bancada con estructura de acero pintada en aluminio bicapa . Asiento y respaldo en poliuretano.
Bench with steel structure painted in aluminium bilayer. Seat and chair back in polyurethane.



h60 w45 d43	15,00	1	1,918
h60 w45 d43	20,00	1	1,699
h60 w45 d43	25,00	1	3,734

Útil para exteriores Outdoor



NIVELADORES NIVELADORES

MODELO MODEL	ESTRUCTURA FRAMEWORK	TIPO PATA LEGS	CÓDIGO CODE	POLIURETANO POLYURETHANE
113	Pintado en aluminio bicapa, o consultar colores. <i>Painted in aluminium bilayer or see colors.</i>		5520L575	245.70
		5720L575	239.40	
170	Pintado en aluminio bicapa, o consultar colores. <i>Painted in aluminium bilayer or see colors.</i>		5530L575	328.65
		5730L575	325.50	
170	Pintado en aluminio bicapa, o consultar colores. <i>Painted in aluminium bilayer or see colors.</i>		5521L575	309.75
		5721L575	305.55	
220	Pintado en aluminio bicapa, o consultar colores. <i>Painted in aluminium bilayer or see colors.</i>		5540L575	407.40
		5740L575	405.30	
220	Pintado en aluminio bicapa, o consultar colores. <i>Painted in aluminium bilayer or see colors.</i>		5531L575	387.45
		5731L575	385.35	

Poliuretano Polyurethane · I





0769

Mesa con estructura de acero termolacado en pintura de poliéster. Tubo de 22 ø. Tapa de madera de pino en los diferentes acabados según tarifa.
 Table with steel structure thermo-lacquered in polyester paint. Tube of 22 ø. Wooden table top in the different finishes according to catalog.



ESTRUCTURA FRAMEWORK	CÓDIGO CODE	
Pintura color blanco text. Colour white textured paint.	07691	1
Pintura color crema text. Colour cream textured paint.	07694	4
Pintura color burdeos text. Bordeaux colour painted.	0769UTX	UTX
Pintura color chocolate. Chococolate color painted.	0769Q	Q
Pintura color gris grafito. Gray graphite colour painted.	0769R	R
Pintura color negro text. Colour black textured paint.	07692	2

MADERA
WOOD

88.00 70
70

Madera Pino Wood - M

MPG MPO MPT MPK MPB

Interiores/cubierto Indoor / Cover

T 75 T 70X70 kg 8,6 00 0,00



0869

Mesa con estructura de acero termolacado en pintura de poliéster. Tubo de 22 ø. Tapa de madera de pino en los diferentes acabados según tarifa.
 Table with steel structure thermo-lacquered in polyester paint. Tube of 22 ø. Wooden table top in the different finishes according to catalog.



ESTRUCTURA FRAMEWORK	CÓDIGO CODE	
Pintura color blanco text. Colour white textured paint.	08691	1
Pintura color crema text. Colour cream textured paint.	08694	4
Pintura color burdeos text. Bordeaux colour painted.	0869UTX	UTX
Pintura color chocolate. Chococolate color painted.	0869Q	Q
Pintura color gris grafito. Gray graphite colour painted.	0869R	R
Pintura color negro text. Colour black textured paint.	08692	2

MADERA
WOOD

110.00 80
80

Madera Pino Wood - M

MPG MPO MPT MPK MPB

Interiores/cubierto Indoor / Cover

T 75 T 80X80 kg 9,4 00 0,00

0779

Mesa con estructura de acero termolacado en pintura de poliéster. Tubo de 22 ø. Tapa de madera de pino en los diferentes acabados según tarifa.
 Table with steel structure thermo-lacquered in polyester paint. Tube of 22 ø. Wooden table top in the different finishes according to catalog.



ESTRUCTURA FRAMEWORK	CÓDIGO CODE	
Pintura color blanco text. Colour white textured paint.	07791	1
Pintura color crema text. Colour cream textured paint.	07794	4
Pintura color burdeos text. Bordeaux colour painted.	0779UTX	UTX
Pintura color chocolate. Chococolate color painted.	0779Q	Q
Pintura color gris grafito. Gray graphite colour painted.	0779R	R
Pintura color negro text. Colour black textured paint.	07792	2

MADERA
WOOD

125.00 70
110

Madera Pino Wood - M

MPG MPO MPT MPK MPB

Interiores/cubierto Indoor / Cover

T 75 T 110 x 70 kg 12 00 0,00

1669

Mesa con estructura de acero termolacado en pintura de poliéster. Tubo de 22 ø. Tapa de madera de pino en los diferentes acabados según tarifa.
 Table with steel structure thermo-lacquered in polyester paint. Tube of 22 ø. Wooden table top in the different finishes according to catalog.



ESTRUCTURA FRAMEWORK	CÓDIGO CODE	
Pintura color blanco text. Colour white textured paint.	16691	1
Pintura color crema text. Colour cream textured paint.	16694	4
Pintura color burdeos text. Bordeaux colour painted.	1669UTX	UTX
Pintura color chocolate. Chococolate color painted.	1669Q	Q
Pintura color gris grafito. Gray graphite colour painted.	1669R	R
Pintura color negro text. Colour black textured paint.	16692	2

MADERA
WOOD

118.00 60
60

Madera Pino Wood - M

MPG MPO MPT MPK MPB

Interiores/cubierto Indoor / Cover

T 110 T 60X60 kg 8,3 - -

0777- 0787- 0788

Mesa con estructura de acero, pintado en aluminio bicapa con tubo de 28 mm. Tapa en los diferentes acabados.
 Table with steel structure painted in aluminium bilayer with pipe of 28 mm. Cover in different finishes.



ESTRUCTURA FRAMEWORK	CÓDIGO CODE	MELAMINA	COMPACTO	COMPACTO D
		MELAMINE	COMPACT	DECO COMPACT
0777 Pintado en aluminio bicapa, o consultar colores <i>Painted in aluminium bilayer or see colors.</i>	0777L	58.00	88.00	94.00

T 71 T 70X70 10,28 33 2,320 70

Apilable Stackable

ESTRUCTURA FRAMEWORK	CÓDIGO CODE	MELAMINA	COMPACTO	COMPACTO D
		MELAMINE	COMPACT	DECO COMPACT
0787 Pintado en aluminio bicapa, o consultar colores <i>Painted in aluminium bilayer or see colors.</i>	0787L	60.00	122.00	124.00
	0787B			
	07871			
	0787N			
	0787T			

T 71 T 80X80 11,50 20 2,254 80

Apilable Stackable

ESTRUCTURA FRAMEWORK	CÓDIGO CODE	COMPACTO
		COMPACT
0788 Pintado en aluminio bicapa, o consultar colores <i>Painted in aluminium bilayer or see colors.</i>	0788L	169.00
	0788B	
	07881	
	0788N	
	0788T	

T 71 T 90X90 16,15 20 2,254 90

Apilable Stackable

- Bicapa aluminizado(L)
Bi-coat aluminized(L)
- Negro (N)
Black (N)
- Negro texturizado (T)
Textured Black (T)
- Blanco (B)
White (B)
- Blanco Mate (1)
Mate White (1)

Compacto (e:10mm) Compact - C

CB C6 CK CJ CT CU C3 CA CN
CG CW CO CE

Melamina (e:19mm) Melamine - F

F

Compacto decorado (e:10mm) Compact - 2

2N 2B 2X

Acero Inoxidable (e:21mm) Stainless Steel - XX

XX



Blanco



Marfil



Crema



Naranja



Rojo



Burdeos



Pistacho



Azul



Negro



Gris



Wenge



Nogal



Magic Negro



Roble



Compacto Inox



Magic Blanco



Melamina



Sólo apto para tapas de material compacto

Ceniceros Integrados

Evita tener ceniceros sobre las mesas. Te ofrecemos la posibilidad de incorporar un cenicero metálico en las nuevas mesas que instales en tu terraza. Sencillo, elegante y fácil de vaciar. Es un complemento perfecto para las zonas de fumadores.

Its avoids to have ashtrays on the tables. We offer you the possibility to incorporate a metallic ashtray in the new tables installed in your terrace. Simple, elegant and easy to empty. It is a perfect complement for the smokers zones.

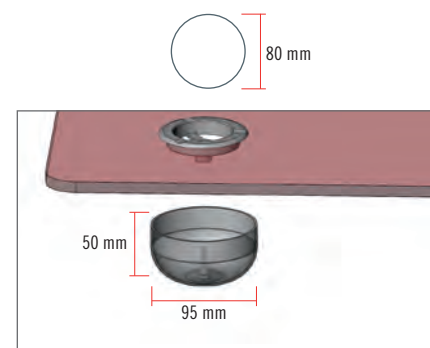

SISTEMA DE VACIADO
Por la parte de abajo de la tapa desroscar el recipiente para vaciar.



EJEMPLO / EXAMPLE

ESTRUCTURA FRAMEWORK	CÓDIGO CODE	COMPACTO COMPACT
Bicapa aluminizado Bi-coat Aluminized	4000L	0.00
4000LCUC4		
MATERIAL MATERIAL	CÓDIGO CODE	PV AÑADIR PV ADD
CENICERO Aluminio Aluminium	C4	0.00

Compacto Compact - C
CU

MATERIAL MATERIAL	CÓDIGO CODE	PV A AÑADIR A LA MESA PV ADD A TABLE
CENICERO Aluminio Aluminium	C4	9.00

Cuidamos los acabados para ofrecerte un producto de calidad para tu negocio.

0661

Mesa con estructura de doble tubo de aluminio anodizado, con tubo de 25 mm. Tapa en los diferentes acabados.
Table with double pipe structure of aluminium anodized with pipe of 25 mm. Cover in different finishes.



ESTRUCTURA FRAMEWORK	CÓDIGO CODE	ACERO INOX STAINLESS STEEL	COMPACTO COMPACT	COMPACTO D DECO COMPACT
Anodizado Anodized	0661Z	69.00	85.00	93.00

T 75 T 60 5,150 20 1,010

Apilable Stackable

Compacto (e:10mm) Compact - C

CB C6 CK CJ CT CU C3 CA CN
CG CW CO CE

Compacto decorado (e:10mm) Compact - 2

2N 2B 2X

Acero Inoxidable (e:21mm) Stainless Steel - XX



0775 - 0875 - 0975

Mesa con estructura de acero pintado en diferentes acabados, con tubo ovalado de 15x20 mm. Tapa en los diferentes acabados.
Table with steel structure painted in different finishes with oval pipe 15x20 mm. Cover in different finishes.



ESTRUCTURA FRAMEWORK	CÓDIGO CODE	COMPACTO D DECO COMPACT	COMPACTO COMPACT	REGRESADO THICKNESS	MADERA LAC. LACQUERED W.
0775 Pintado en aluminio bicapa, o consultar colores Painted in aluminium bilayer or see colors.	0775L	105.00	103.50	121.00	162.00

T 75 T 70X70 12,00 25 2,320

0771 - 0881

Mesa con estructura de doble tubo de aluminio anodizado, con tubo de 25 mm. Tapa en los diferentes acabados.
Table with double pipe structure of aluminium anodized with pipe of 25 mm. Cover in different finishes.



ESTRUCTURA FRAMEWORK	CÓDIGO CODE	ACERO INOX STAINLESS STEEL	COMPACTO COMPACT	COMPACTO D DECO COMPACT
0771 Anodizado Anodized	0771Z	105.00	120.00	130.00

T 75 T 70X70 6,70 24 2,121

Apilable Stackable

ESTRUCTURA FRAMEWORK	CÓDIGO CODE	ACERO INOX STAINLESS STEEL	COMPACTO COMPACT	COMPACTO D DECO COMPACT
0881 Anodizado Anodized	0881Z	115.00	135.00	148.00

T 75 T 80X80 7,6 24 2,121

Apilable Stackable

Compacto (e:10mm) Compact - C

CB C6 CK CJ CT CU C3 CA CN
CG CW CO CE

Compacto decorado (e:10mm) Compact - 2

2N 2B 2X

Acero Inoxidable (e:21mm) Stainless Steel - XX



ESTRUCTURA FRAMEWORK	CÓDIGO CODE	COMPACTO COMPACT	REGRESADO THICKNESS
0875 Pintado en aluminio bicapa, o consultar colores Painted in aluminium bilayer or see colors.	0875L	135.50	144.00

T 75 T 80X80 14,00 20 2,254



ESTRUCTURA FRAMEWORK	CÓDIGO CODE	COMPACTO COMPACT	REGRESADO THICKNESS
0975 Pintado en aluminio bicapa, o consultar colores Painted in aluminium bilayer or see colors.	0975L	159.60	170.00

T 75 T 90X90 17,00 20 2,254

Compacto (e:10mm) Compact - C

CB C6 CK CJ CT CU C3 CA CN
CG CW CO CE

Compacto decorado (e:10mm) Compact - 2

2N 2B 2X

Regresado (e:40mm) Thicknesser (e:40mm) - G

GB GN GZ GW

Madera (e:22mm) Wood - M

MH MF MO MW

0774

EGEO · Mesa con estructura de acero pintada en aluminio bicapa, negro o marfil de 30x30 mm. Tapa de compacto.
Table with painted steel structure with tube of 30x30 mm. Cover in compact.



ESTRUCTURA FRAMEWORK	CÓDIGO CODE	COMPACTO COMPACT
Pintado en color aluminio, negro o marfil <i>Painted in aluminium bilayer or see colors.</i>	0774L	106.70

T 75 T 70x70 13,4 25 2,320 70

Compacto Compact · C

CB	C6	CK	CJ	CT	CU	C3	CA	CN	CG	CW	CO	CE
----	----	----	----	----	----	----	----	----	----	----	----	----

	Apilable Stackable
	Interiores Indoor
	Útil para exteriores Outdoor

0784

EGEO · Mesa con estructura de acero pintada en aluminio bicapa, negro o marfil de 30x30 mm. Tapa de compacto.
Table with painted steel structure with tube of 30x30 mm. Cover in compact.



ESTRUCTURA FRAMEWORK	CÓDIGO CODE	COMPACTO COMPACT
Pintado en color aluminio, negro o marfil <i>Painted in aluminium bilayer or see colors.</i>	0784L	152.80

T 75 T 80x80 15 25 2,320 80

Compacto Compact · C

CB	C6	CK	CJ	CT	CU	C3	CA	CN	CG	CW	CO	CE
----	----	----	----	----	----	----	----	----	----	----	----	----

	Apilable Stackable
	Interiores Indoor
	Útil para exteriores Outdoor

0785

EGEO · Mesa con estructura de acero pintada en aluminio bicapa, negro o marfil de 30x30 mm. Tapa de compacto.
Table with painted steel structure with tube of 30x30 mm. Cover in compact.



ESTRUCTURA FRAMEWORK	CÓDIGO CODE	COMPACTO COMPACT
Pintado en color aluminio, negro o marfil <i>Painted in aluminium bilayer or see colors.</i>	0785L	205.00

T 75 T 90x90 15,42 25 2,320 90

Compacto Compact · C

CB	C6	CK	CJ	CT	CU	C3	CA	CN	CG	CW	CO	CE
----	----	----	----	----	----	----	----	----	----	----	----	----

4002 - 4003 - 4004

Mesa con estructura de aluminio pintado con diferentes acabados y tubo de 40x40, tapa de compacto.
Table with painted in aluminium structure with tube of 40x40 mm. Cover in compact.



ESTRUCTURA FRAMEWORK	CÓDIGO CODE	COMPACTO COMPACT
4002 Pintado en aluminio bicapa, o consultar colores <i>Painted in aluminium bilayer or see colors.</i>	4002L	207.90

T 75 T 70x70 12,5 15 2,880 70

ESTRUCTURA FRAMEWORK	CÓDIGO CODE	COMPACTO COMPACT
4003 Pintado en aluminio bicapa, o consultar colores <i>Painted in aluminium bilayer or see colors.</i>	4003L	281.40

T 75 T 80x80 14,00 15 2,880 80

ESTRUCTURA FRAMEWORK	CÓDIGO CODE	COMPACTO COMPACT
4004 Pintado en aluminio bicapa, o consultar colores <i>Painted in aluminium bilayer or see colors.</i>	4004L	336.00

T 75 T 90x90 15,00 15 2,880 90

Compacto Compact · C

CB	C6	CK	CJ	CT	CU	C3	CA	CN	CG	CW	CO	CE
----	----	----	----	----	----	----	----	----	----	----	----	----

	Apilable Stackable
	Sólo en interiores Indoor
	Útil para exteriores Outdoor

4200 - 4205 - 4210

Mesa con estructura de aluminio pintado con diferentes acabados y tubo de 40x40, tapa de compacto encastrado.
Table with coated aluminium frame, different finishes, in 40x40mm tube. Cover made of embedded compact.



ESTRUCTURA FRAMEWORK	CÓDIGO CODE	COMPACTO COMPACT
4200 Pintado en aluminio bicapa, o consultar colores <i>Painted in aluminium bilayer or see colors.</i>	4200L	207.90

T 75 T 70x70 13,00 15 2,600 70

ESTRUCTURA FRAMEWORK	CÓDIGO CODE	COMPACTO COMPACT
4205 Pintado en aluminio bicapa, o consultar colores <i>Painted in aluminium bilayer or see colors.</i>	4205L	281.40

T 75 T 80x80 14,00 15 2,880 80

ESTRUCTURA FRAMEWORK	CÓDIGO CODE	COMPACTO COMPACT
4210 Pintado en aluminio bicapa, o consultar colores <i>Painted in aluminium bilayer or see colors.</i>	4210L	336.00

T 75 T 90x90 15,00 15 2,920 90

Compacto Compact · C

CB	C6	CK	CJ	CT	CU	C3	CA	CN	CG	CW	CO	CE
----	----	----	----	----	----	----	----	----	----	----	----	----

	Apilable Stackable
	Sólo en interiores Indoor
	Útil para exteriores Outdoor

0660 - 0667 - 0695

Mesa con estructura de acero pintado en aluminio bicapa o blanco, con tubo de 28 mm. Tapa en los diferentes acabados.
Table with steel structure painted aluminium bilayer or whit, with pipe of 28 mm. Cover in different finishes.



ESTRUCTURA FRAMEWORK	CÓDIGO CODE	MELAMINA MELAMINE	COMPACTO COMPACT
		50.40	91.35
0660 Pintado en aluminio bicapa, o consultar colores <i>Painted in aluminium bilayer or see colors.</i>	0660L 0660B		

T 75 T 60 7,000 30 1,305 60



ESTRUCTURA FRAMEWORK	CÓDIGO CODE	MELAMINA MELAMINE	COMPACTO COMPACT
		61.95	106.05
0667 Pintado en aluminio bicapa, o consultar colores <i>Painted in aluminium bilayer or see colors.</i>	0667L 0667B		

T 75 T 70 8,000 20 1,010 70



ESTRUCTURA FRAMEWORK	CÓDIGO CODE	MELAMINA MELAMINE	COMPACTO COMPACT
		67.02	132.30
0695 Pintado en aluminio bicapa, o consultar colores <i>Painted in aluminium bilayer or see colors.</i>	0695L 0695B		

T 75 T 80 10,00 25 2,120 80

Interiores/cubierto *Indoor/cover*
Útil para exteriores *Outdoor*

Compacto (e:10mm) Compact - C

- CB
- C6
- CK
- CJ
- CT
- CU
- C3
- CA
- CN

Compacto decorado (e:10mm) Compact - 2

- 2N
- 2B
- 2X

Melamina (e:19mm) Melamine - F

- F

0607 - 0888 - 0829

Mesa con estructura de acero pintado en los diferentes acabados de pintura o cromo. Tapa en los diferentes acabados. Patas de tubo redondo de 40.Table with steel structure painted in different finishes or chrome. Cover in different finishes.



ARMAZÓN:

- Bicapa aluminizado(L)
Bi-coat aluminized(L)
- Blanco (B)
White (B)
- Negro (N)
Black (N)



PATAS:

- Bicapa aluminizado(L)
Bi-coat aluminized(L)
- Negro (N)
Black (N)
- Cromo (C)
Chrome (C)
- Blanco (B)
White (B)

Interiores/cubierto *Indoor/cover*

Útil para exteriores *Outdoor*

Compacto (e:10mm) Compact - C

- CB
- C6
- CK
- CJ
- CT
- CU
- C3
- CA
- CN

Melamina (e:19mm) Melamine - F

- F

ESTRUCTURA FRAMEWORK	CÓDIGO CODE	MELAMINA MELAMINE	COMPACTO COMPACT
		90.30	135.45
0607 Estructura en bicapa aluminizado o negro y patas de acero pintadas en bicapa aluminizado o negro <i>Bi-layer aluminized or black frame and bi-coat aluminized or black steel tube</i>	0607L 0607N		
Estructura en Blanco y patas de aluminio pintadas en blanco <i>White frame and white painted in aluminium tube</i>	0607B	103.95	149.10
Estructura en bicapa aluminizado y patas cromadas <i>Bi-layer aluminized frame and chromed tube</i>	0607C	97.00	140.00

T 75 T 70X70 9,800 1 0,060 70

ESTRUCTURA FRAMEWORK	CÓDIGO CODE	MELAMINA MELAMINE	COMPACTO COMPACT
		92.40	157.50
0888 Estructura en bicapa aluminizado o negro y patas de acero pintadas en bicapa aluminizado o negro <i>Bi-coat aluminized or black frame and bi-coat aluminized or black steel tube</i>	0888L 0888N		
Estructura en Blanco y patas de aluminio pintadas en blanco <i>White frame and white painted in aluminium tube</i>	0888B	106.05	170.10
Estructura en bicapa aluminizado y patas cromadas <i>Bi-coat aluminized frame and chromed tube</i>	0888C	103.95	168.00

T 75 T 80X80 12,50 1 0,078 80

ESTRUCTURA FRAMEWORK	CÓDIGO CODE	MELAMINA MELAMINE	COMPACTO COMPACT
		123.90	215.25
0829 Estructura en bicapa aluminizado o negro y patas de acero pintadas en bicapa aluminizado o negro <i>Bi-coat aluminized or black frame and bi-coat aluminized or black steel tube</i>	0829L 0829N		
Estructura en Blanco y patas de aluminio pintadas en blanco <i>White frame and white painted in aluminium tube</i>	0829B	141.75	233.10
Estructura en bicapa aluminizado y patas cromadas <i>Bi-coat aluminized frame and chromed tube</i>	0829C	137.55	229.95

T 75 T 120X80 18,00 1 0,124 80

4000 - 4005

Mesa con estructura de acero pintado en los diferentes acabados de pintura o acero inoxidable, con tubo de 40x40 mm. Tapa en los diferentes acabados.
 Table with steel structure painted in different finishes or stainless steel with pipe of 40x40 mm. Cover in different finishes.



ESTRUCTURA FRAMEWORK	CÓDIGO CODE	COMPACTO	COMPACTO D	CRISTAL TR.	CRISTAL OP.	CRISTAL COL
		COMPACT	COMPACT DEC	COMPACT	COMPACT	COMPACT
4000 Pintado en aluminio bicapa, o consultar colores <i>Painted in aluminium bilayer or see colors.</i>	4000L	160.65	159.60	188.00	195.00	209.00
	40001					
	4000T					
Acero Inoxidable <i>Stainless Steel</i>	4000X	263.55	●	297.00	301.00	314.00

T 75 T 70X70 16,50 1 0,076 70



ESTRUCTURA FRAMEWORK	CÓDIGO CODE	COMPACTO	COMPACTO D	CRISTAL TR.	CRISTAL OP.	CRISTAL COL
		COMPACT	COMPACT DEC	COMPACT	COMPACT	COMPACT
4005 Pintado en aluminio bicapa, o consultar colores <i>Painted in aluminium bilayer or see colors.</i>	4005L	181.00	193.20	212.00	239.40	262.00
	40051					
	4005T					
Acero Inoxidable <i>Stainless Steel</i>	4005X	340.00	●	262.00	393.00	419.00

T 75 T 80X80 22,40 1 0,087 80

4010 - 4015



ESTRUCTURA FRAMEWORK	CÓDIGO CODE	COMPACTO	COMPACTO D	CRISTAL TR.	CRISTAL OP.	CRISTAL COL
		COMPACT	COMPACT DEC	COMPACT	COMPACT	COMPACT
4010 Pintado en aluminio bicapa, o consultar colores <i>Painted in aluminium bilayer or see colors.</i>	4010L	208.00	242.00	272.00	316.00	327.00
	40101					
	4010T					
Acero Inoxidable <i>Stainless Steel</i>	4010X	361.00	●	420.00	453.00	475.00

T 75 T 110X70 23,60 1 0,133 70

ESTRUCTURA FRAMEWORK	CÓDIGO CODE	COMPACTO	COMPACTO D	CRISTAL TR.	CRISTAL OP.	CRISTAL COL
		COMPACT	COMPACT DEC	COMPACT	COMPACT	COMPACT
4015 Pintado en aluminio bicapa, o consultar colores <i>Painted in aluminium bilayer or see colors.</i>	4015L	223.65	251.00	300.00	340.00	365.00
	40151					
	4015T					
Acero Inoxidable <i>Stainless Steel</i>	4015X	379.00	●	464.00	505.00	530.00

T 75 T 120X80 24,70 1 0,520 80

Compacto (e:10mm) Compact - C



Compacto decorado (e:10mm) Compact - 2

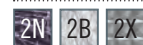

Cristal (e:10mm) Crystal (e:10mm) - Q



4027 - 4028 - 4029

Mesa con estructura de acero pintado en los diferentes acabados de pintura o acero inoxidable, con tubo de 40x40 mm. Tapa en los diferentes acabados.
 Table with steel structure painted in different finishes or stainless steel with pipe of 40x40 mm. Cover in different finishes.



ESTRUCTURA FRAMEWORK	CÓDIGO CODE	COMPACTO
		COMPACT
4027 Pintado en aluminio bicapa, o consultar colores <i>Painted in aluminium bilayer or see colors.</i>	4027L	268.00
	40271	
Acero Inoxidable <i>Stainless Steel</i>	4027X	442.00

T 75 T 140X80 25,72 1 0,380 80



ESTRUCTURA FRAMEWORK	CÓDIGO CODE	COMPACTO
		COMPACT
4028 Pintado en aluminio bicapa, o consultar colores <i>Painted in aluminium bilayer or see colors.</i>	4028L	297.00
	40281	
Acero Inoxidable <i>Stainless Steel</i>	4028X	475.00

T 75 T 160X80 30,60 1 0,400 80



ESTRUCTURA FRAMEWORK	CÓDIGO CODE	COMPACTO
		COMPACT
4029 Pintado en aluminio bicapa, o consultar colores <i>Painted in aluminium bilayer or see colors.</i>	4029L	324.00
	40291	
Acero Inoxidable <i>Stainless Steel</i>	4029X	511.00

T 75 T 180X80 33,76 1 0,520 80

Interiores/cubierto *Indoor/cover*

Compacto (e:10mm) Compact - C



4021 - 4022 - 4023 - 4024

Mesa con estructura de acero pintado en los diferentes acabados de pintura o acero inoxidable, con tubo de 40x40 mm. Tapa en compacto.

Table with steel structure painted in diferent finishes or Stainless Steel with pipe of 40x40 mm. Cover in compact.



ESTRUCTURA FRAMEWORK	CÓDIGO CODE
Pintado en aluminio bicapa, o consultar colores <i>Painted in aluminium bilayer or see colors.</i>	4021L 40211
Acero Inoxidable <i>Stainless Steel</i>	4021X

COMPACTO COMPACT
184.00
333.00

T 75	T 120X45	kg 18,00	1	0,158
------	----------	----------	---	-------

45	120
----	-----

Bicapa aluminizado(L) Blanco Mate (1)
Bi-coat aluminized(L) Mate White (1)



ESTRUCTURA FRAMEWORK	CÓDIGO CODE
Pintado en aluminio bicapa, o consultar colores <i>Painted in aluminium bilayer or see colors.</i>	4022L 40221
Acero Inoxidable <i>Stainless Steel</i>	4022X

COMPACTO COMPACT
208.00
364.00

T 75	T 140X45	kg 22,00	1	0,260
------	----------	----------	---	-------

45	140
----	-----



ESTRUCTURA FRAMEWORK	CÓDIGO CODE
Pintado en aluminio bicapa, o consultar colores <i>Painted in aluminium bilayer or see colors.</i>	4023L 40231
Acero Inoxidable <i>Stainless Steel</i>	4023X

COMPACTO COMPACT
216.00
383.00

T 75	T 160X45	kg 26,00	1	0,320
------	----------	----------	---	-------

45	160
----	-----



ESTRUCTURA FRAMEWORK	CÓDIGO CODE
Pintado en aluminio bicapa, o consultar colores <i>Painted in aluminium bilayer or see colors.</i>	4024L 40241
Acero Inoxidable <i>Stainless Steel</i>	4024X

COMPACTO COMPACT
226.00
402.00

T 75	T 180X45	kg 31,00	1	0,380
------	----------	----------	---	-------

45	180
----	-----

Interiores *Indoor*
 Útil para exteriores *Outdoor*

Compacto (e:10mm) *Compact - C*

CB	C6	CK	CJ	CT	CU	C3	CA	CN
CG	CW	CO	CE					

EJEMPLOS DE UTILIZACIÓN

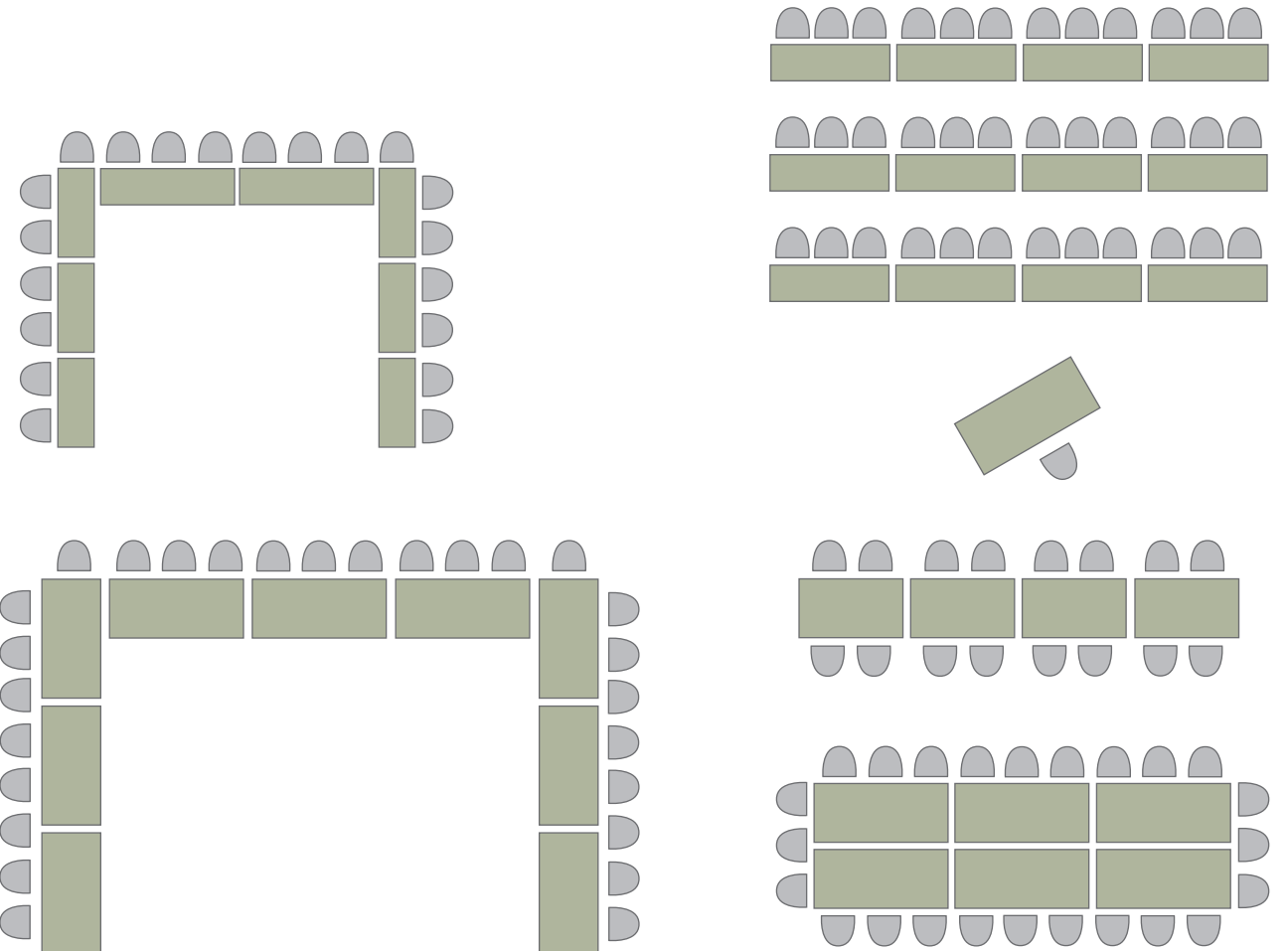

4001

Mesa con estructura de acero pintado en los diferentes acabados de pintura, con tubo de 40x40 mm. Tapa en compacto.
Table with steel structure painted in diferent finishes with pipe of 40x40 mm. Cover in compact.



ESTRUCTURA FRAMEWORK	CÓDIGO CODE
Pintado en aluminio bicapa, o consultar colores <i>Painted in aluminium bilayer or see colors.</i>	4001L

COMPACTO COMPACT
161.00

T 110	T 60X60	kg 15,50	1	0,211
-------	---------	----------	---	-------

60	60
----	----

Interiores *Indoor*
 Útil para exteriores *Outdoor*

Compacto (e:10mm) *Compact - C*

CB	C6	CK	CJ	CT	CU	C3	CA	CN
CG	CW	CO	CE					

1094 - 1093

Mesa con estructura de acero, pintado en aluminio bicapa con tubo de 60 X 60 mm. Tapa en compacto.
Table with steel structure painted in aluminium bilayer with pipe of 60 X 60 mm. Cover in compact.



ESTRUCTURA FRAMEWORK	CÓDIGO CODE	COMPACTO	
		COMPACT	COMPACTO DECO COMPACT DECO
1094 Pintado en aluminio bicapa, o consultar colores <i>Painted in aluminium bilayer or see colors.</i>	1094L	176.00	183.00

T 75 T 70 12,7 1 0,037 70

ESTRUCTURA FRAMEWORK	CÓDIGO CODE	COMPACTO	
		COMPACT	COMPACTO DECO COMPACT DECO
1093 Pintado en aluminio bicapa, o consultar colores <i>Painted in aluminium bilayer or see colors.</i>	1093L	176.00	183.00

T 75 T 70X70 14,2 1 0,037 70

1098 - 1099



ESTRUCTURA FRAMEWORK	CÓDIGO CODE	COMPACTO	
		COMPACT	COMPACTO DECO COMPACT DECO
1098 Pintado en aluminio bicapa, o consultar colores <i>Painted in aluminium bilayer or see colors.</i>	1098L	193.00	200.00

T 75 T 80 14,86 1 0,037 80

ESTRUCTURA FRAMEWORK	CÓDIGO CODE	COMPACTO	
		COMPACT	COMPACTO DECO COMPACT DECO
1099 Pintado en aluminio bicapa, o consultar colores <i>Painted in aluminium bilayer or see colors.</i>	1099L	193.00	200.00

T 75 T 80X80 16,36 1 0,037 80

1092 - 1092/1



ESTRUCTURA FRAMEWORK	CÓDIGO CODE	COMPACTO COMPACT	
1092 Pintado en aluminio bicapa, o consultar colores <i>Painted in aluminium bilayer or see colors.</i>	1092L	159.60	60 15
1092 Pintado en aluminio bicapa, o consultar colores <i>Painted in aluminium bilayer or see colors.</i>	1092L	159.60	60 16
1092/1 Pintado en aluminio bicapa, o consultar colores <i>Painted in aluminium bilayer or see colors.</i>	1092/1L	180.60	70 16,3
1092/1 Pintado en aluminio bicapa, o consultar colores <i>Painted in aluminium bilayer or see colors.</i>	1092/1L	180.60	70 17,8

Interiores Indoor Útil para exteriores Outdoor
 T 110 1 0,054

1084 - 1083 - 1088 - 1089

Mesa con estructura de acero, pintado en aluminio bicapa con tubo de 65 mm. Tapa en los diferentes acabados.
Table with steel structure painted aluminium bilayer with pipe of 65 mm. Cover in different finishes.



ESTRUCTURA FRAMEWORK	CÓDIGO CODE	COMPACTO		
		COMPACT	COMPACTO DECO COMPACT DECO	
1084 Pintado en aluminio bicapa, o consultar colores <i>Painted in aluminium bilayer or see colors.</i>	1084L	142.80	152.25	60 12,2
1083 Pintado en aluminio bicapa, o consultar colores <i>Painted in aluminium bilayer or see colors.</i>	1083L	142.80	152.25	60 13,2
1088 Pintado en aluminio bicapa, o consultar colores <i>Painted in aluminium bilayer or see colors.</i>	1088L	146.00	154.35	70 13,5
1089 Pintado en aluminio bicapa, o consultar colores <i>Painted in aluminium bilayer or see colors.</i>	1089L	146.00	154.35	70 15

T 75 1 0,037

1087 - 1086



ESTRUCTURA FRAMEWORK	CÓDIGO CODE	COMPACTO		
		COMPACT	COMPACTO DECO COMPACT DECO	
1087 Pintado en aluminio bicapa, o consultar colores <i>Painted in aluminium bilayer or see colors.</i>	1087L	143.85	153.30	60 18
1086 Pintado en aluminio bicapa, o consultar colores <i>Painted in aluminium bilayer or see colors.</i>	1086L	147.00	156.00	70 19,3

T 110 1 0,037

Interiores Indoor
 Útil para exteriores Outdoor

Compacto (e:10mm) Compact - C

CB C6 CK CJ CT CU C3 CA CN
CG CW CO CE

Compacto decorado (e:10mm) Compact - 2

2N 2B 2X



1041 - 1042

Mesa con estructura de acero, pintado en aluminio bicapa con tubo de 65 mm. Tapa en los diferentes acabados.
Table with steel structure painted aluminium bilayer with pipe of 65 mm. Cover in different finishes.



ESTRUCTURA FRAMEWORK	CÓDIGO CODE	COMPACTO COMPACT			COMPACTO DECO COMPACT DECO			ESTRATIFICADO STRATIFIED		
		COMPACT	COMPACT DECO	ESTRATIFICADO	COMPACT	COMPACT DECO	ESTRATIFICADO	COMPACT	COMPACT DECO	ESTRATIFICADO
1041	Pintado en aluminio bicapa, o consultar colores <i>Painted in aluminium bilayer or see colors.</i>	1041L	140.00	149.50	•	60				
1041	Pintado en aluminio bicapa, o consultar colores <i>Painted in aluminium bilayer or see colors.</i>	1041L	140.00	149.50	140.00	60				
1042	Pintado en aluminio bicapa, o consultar colores <i>Painted in aluminium bilayer or see colors.</i>	1042L	149.00	159.00	•	70				
1042	Pintado en aluminio bicapa, o consultar colores <i>Painted in aluminium bilayer or see colors.</i>	1042L	149.00	159.00	149.00	70				

T 75 15,00 1 0,037

1043 - 1044



ESTRUCTURA FRAMEWORK	CÓDIGO CODE	COMPACTO COMPACT			COMPACTO DECO COMPACT DECO			ESTRATIFICADO STRATIFIED		
		COMPACT	COMPACT DECO	ESTRATIFICADO	COMPACT	COMPACT DECO	ESTRATIFICADO	COMPACT	COMPACT DECO	ESTRATIFICADO
1043	Pintado en aluminio bicapa, o consultar colores <i>Painted in aluminium bilayer or see colors.</i>	1043L	135.00	144.00	•	60				
1043	Pintado en aluminio bicapa, o consultar colores <i>Painted in aluminium bilayer or see colors.</i>	1043L	135.00	144.00	135.00	60				
1044	Pintado en aluminio bicapa, o consultar colores <i>Painted in aluminium bilayer or see colors.</i>	1044L	144.00	153.00	•	70				
1044	Pintado en aluminio bicapa, o consultar colores <i>Painted in aluminium bilayer or see colors.</i>	1044L	144.00	153.00	144.00	70				

T 75 15,60 1 0,037

1045 - 1046



ESTRUCTURA FRAMEWORK	CÓDIGO CODE	COMPACTO COMPACT			COMPACTO DECO COMPACT DECO			ESTRATIFICADO STRATIFIED		
		COMPACT	COMPACT DECO	ESTRATIFICADO	COMPACT	COMPACT DECO	ESTRATIFICADO	COMPACT	COMPACT DECO	ESTRATIFICADO
1045	Pintado en aluminio bicapa, o consultar colores <i>Painted in aluminium bilayer or see colors.</i>	1045L	140.00	150.00	•	60				
1045	Pintado en aluminio bicapa, o consultar colores <i>Painted in aluminium bilayer or see colors.</i>	1045L	140.00	150.00	140.00	60				
1046	Pintado en aluminio bicapa, o consultar colores <i>Painted in aluminium bilayer or see colors.</i>	1046L	149.00	159.00	•	70				
1046	Pintado en aluminio bicapa, o consultar colores <i>Painted in aluminium bilayer or see colors.</i>	1046L	149.00	159.00	149.00	70				

T 75 12,80 1 0,037

Interiores Indoor
 Útil para exteriores Outdoor

Estratificado Stratified - E

EB EU EN

Compacto decorado (e:10mm) Compact - 2

2N 2B 2X

Compacto (e:10mm) Compact - C

CB C6 CK CJ CT CU C3 CA CN
CG CW CO CE

1047 - 1048

Mesa con estructura de acero, pintado en aluminio bicapa con tubo de 65 mm. Tapa en los diferentes acabados.
Table with steel structure painted aluminium bilayer with pipe of 65 mm. Cover in different finishes.



ESTRUCTURA FRAMEWORK	CÓDIGO CODE	COMPACTO COMPACT			COMPACTO DECO COMPACT DECO			ESTRATIFICADO STRATIFIED		
		COMPACT	COMPACT DECO	ESTRATIFICADO	COMPACT	COMPACT DECO	ESTRATIFICADO	COMPACT	COMPACT DECO	ESTRATIFICADO
1047	Pintado en aluminio bicapa, o consultar colores <i>Painted in aluminium bilayer or see colors.</i>	1047L	140.00	149.50	•	60				
1047	Pintado en aluminio bicapa, o consultar colores <i>Painted in aluminium bilayer or see colors.</i>	1047L	140.00	149.50	140.00	60				
1048	Pintado en aluminio bicapa, o consultar colores <i>Painted in aluminium bilayer or see colors.</i>	1048L	149.50	159.00	•	70				
1048	Pintado en aluminio bicapa, o consultar colores <i>Painted in aluminium bilayer or see colors.</i>	1048L	149.50	159.00	149.50	70				

T 75 12,60 1 0,037

Interiores Indoor
 Útil para exteriores Outdoor

1060 - 1061

Mesa con estructura de acero inoxidable con tubo de 65 mm. Tapa en los diferentes acabados.
Table with stainless steel structure with pipe of 65 mm. Cover in different finishes.



ESTRUCTURA FRAMEWORK	CÓDIGO CODE	COMPACTO COMPACT			COMPACTO DECO COMPACT DECO			ESTRATIFICADO STRATIFIED		
		COMPACT	COMPACT DECO	ESTRATIFICADO	COMPACT	COMPACT DECO	ESTRATIFICADO	COMPACT	COMPACT DECO	ESTRATIFICADO
1060	Pintado en aluminio bicapa, o consultar colores <i>Painted in aluminium bilayer or see colors.</i>	1060X	206.00	3016.00	•	60				
1060	Pintado en aluminio bicapa, o consultar colores <i>Painted in aluminium bilayer or see colors.</i>	1060X	206.00	216.00	206.00	60				
1061	Pintado en aluminio bicapa, o consultar colores <i>Painted in aluminium bilayer or see colors.</i>	1061X	215.00	225.00	•	70				
1061	Pintado en aluminio bicapa, o consultar colores <i>Painted in aluminium bilayer or see colors.</i>	1061X	215.00	225.00	215.00	70				

T 75 20 1 0,037

Interiores Indoor
 Útil para exteriores Outdoor

Compacto (e:10mm) Compact - C

CB C6 CK CJ CT CU C3 CA CN
CG CW CO CE

Compacto decorado (e:10mm) Compact - 2

2N 2B 2X

Estratificado Stratified - E

EB EU EN

1016 - 1018

Mesa con estructura de acero pintado en los diferentes acabados de pintura o acero inoxidable con tubo de 80x80 mm. Tapa en los diferentes acabados.
Table with steel structure painted in different finishes or Stainless Steel with pipe of 80x80 mm. Cover with the same finishes.



- Bicapa aluminizado(L)
Bi-coat aluminized(L)
- Negro Texturizado (T)
Textured Black (T)
- Blanco Mate (1)
Mate White (1)

ESTRUCTURA FRAMEWORK	CÓDIGO CODE	COMPACTO	COMPACTO D	REGRUESADO	MADERA
		COMPACT	COMPACT DEC	THICKNESSER	WOOD
1016 Pintado en aluminio bicapa, o consultar colores Painted in aluminium bilayer or see colors.	1016L	210.00	217.00	●	251.00
	1016I				
	1016T				
Acero Inoxidable Stainless Steel	1016X	258.00	265.00	●	300.00

T 75 T 70 20,50 1 0,030 70

ESTRUCTURA FRAMEWORK	CÓDIGO CODE	COMPACTO	COMPACTO D	REGRUESADO	MADERA
		COMPACT	COMPACT DEC	THICKNESSER	WOOD
1018 Pintado en aluminio bicapa, o consultar colores Painted in aluminium bilayer or see colors.	1018L	210.00	217.00	217.00	251.00
	1018I				
	1018T				
Acero Inoxidable Stainless Steel	1018X	258.00	265.00	265.00	300.00

T 75 T 70x70 22,00 1 0,030 70

- Interiores/cubierto Indoor/cover
- Útil para exteriores Outdoor

1022 - 1024



- Bicapa aluminizado(L)
Bi-coat aluminized(L)
- Negro Texturizado (T)
Textured Black (T)
- Blanco Mate (1)
Mate White (1)

ESTRUCTURA FRAMEWORK	CÓDIGO CODE	COMPACTO	COMPACTO D	REGRUESADO	MADERA
		COMPACT	COMPACT DEC	THICKNESSER	WOOD
1022 Pintado en aluminio bicapa, o consultar colores Painted in aluminium bilayer or see colors.	1022L	222.00	234.00	●	268.00
	1022I				
	1022T				
Acero Inoxidable Stainless Steel	1022X	273.00	285.00	●	318.00

T 75 T 80 23,80 1 0,030 80

ESTRUCTURA FRAMEWORK	CÓDIGO CODE	COMPACTO	COMPACTO D	REGRUESADO	MADERA
		COMPACT	COMPACT DEC	THICKNESSER	WOOD
1024 Pintado en aluminio bicapa, o consultar colores Painted in aluminium bilayer or see colors.	1024L	222.00	234.00	226.00	268.00
	1024I				
	1024T				
Acero Inoxidable Stainless Steel	1024X	273.00	285.00	276.00	318.00

T 75 T 80x80 24,16 1 0,030 80

- Interiores/cubierto Indoor/cover
- Útil para exteriores Outdoor

Madera (e:22mm) Wood - M

- MH MF MO MW

Regruesado (e:40mm) Thicknesser (e:40mm) - G

- GB GN GZ GW

NOTA: El Regruesado se fabrican sólo en tapa cuadrada
NOTE: Thicknesser is manufactured in Squared top only

Compacto decorado (e:10mm) Compact - 2

- 2N 2B 2X

Compacto (e:10mm) Compact - C

- CB C6 CK CJ CT CU C3 CA CN

- CG CW CO CE

1073 - 1074

Mesa con estructura de acero pintado en los diferentes acabados de pintura o acero inoxidable con tubo de 80x80 mm. Tapa en los diferentes acabados.
Table with steel structure painted in different finishes or Stainless Steel with pipe of 80x80 mm. Cover with the same finishes.



ESTRUCTURA FRAMEWORK	CÓDIGO CODE	CRISTAL TRANSP.	CRISTAL OPACO	CRISTAL COLORES
		TRANS. CRYSTAL	OPAQUE CRYSTAL	COLOURS CRYSTAL
1073 Pintado en aluminio bicapa, o consultar colores Painted in aluminium bilayer or see colors.	1073L	285.00	306.00	321.00
	1073I			
	1073T			
Acero Inoxidable Stainless Steel	1073X	339.00	361.00	376.00

T 75 T 70 23,00 1 0,030 70

ESTRUCTURA FRAMEWORK	CÓDIGO CODE	CRISTAL TRANSP.	CRISTAL OPACO	CRISTAL COLORES
		TRANS. CRYSTAL	OPAQUE CRYSTAL	COLOURS CRYSTAL
1074 Pintado en aluminio bicapa, o consultar colores Painted in aluminium bilayer or see colors.	1074L	305.00	331.00	347.00
	1074I			
	1074T			
Acero Inoxidable Stainless Steel	1074X	359.00	385.00	402.00

T 75 T 80 24,50 1 0,030 80

Sólo en interiores Indoor

Cristal (e:10mm) Crystal (e:10mm) - Q

- QO QS QJ QU Q3 QN

1017

Mesa con estructura de acero pintado en los diferentes acabados de pintura o acero inoxidable con tubo de 80x80 mm. Tapa en los diferentes acabados.
Table with steel structure painted in different finishes or Stainless Steel with pipe of 80x80 mm. Cover with the same finishes.



ESTRUCTURA FRAMEWORK	CÓDIGO CODE	COMPACTO	COMPACTO DECO	MADERA
		COMPACT	COMPACT DEC	WOOD
1017 Pintado en aluminio bicapa, o consultar colores Painted in aluminium bilayer or see colors.	1017L	201.60	206.00	238.00
	1017I			
	1017T			
Acero Inoxidable Stainless Steel	1017X	258.00	262.00	295.00

T 110 T 60 25,70 1 0,060 60

Sólo en interiores Indoor

Compacto (e:10mm) Compact - C

- CB C6 CK CJ CT CU C3 CA CN

- CG CW CO CE

Compacto decorado (e:10mm) Compact - 2

- 2N 2B 2X

Madera (e:22mm) Wood - M

- MH MF MO MW

1019 - 1023

Mesa con estructura de acero pintado en los diferentes acabados o acero inoxidable con tubo de 80x80 mm. Tapa en los diferentes acabados.
 Table with steel structure painted in different finishes or Stainless Steel with pipe of 80x80 mm. Cover with the same finishes.



- Bicapa aluminizado(L) Bi-coat aluminized(L)
- Negro Texturizado (T) Textured Black (T)
- Blanco Mate (1) Mate White (1)

ESTRUCTURA FRAMEWORK	CÓDIGO CODE				
		COMPACTO COMPACT	COMPACTO D COMPACT DEC.	REGRESADO THICKNESS	MADERA WOOD
1019 Pintado en aluminio bicapa, o consultar colores Painted in aluminium bilayer or see colors.	1019L	335.00	362.00	344.00	377.00
	1019I				
	1019T				
Acero Inoxidable Stainless Steel	1019X	418.00	449.00	427.00	460.00

T 110 T 110x70 36,84 1 0,350 70

ESTRUCTURA FRAMEWORK	CÓDIGO CODE				
		COMPACTO COMPACT	COMPACTO D COMPACT DEC.	REGRESADO THICKNESS	MADERA WOOD
1023 Pintado en aluminio bicapa, o consultar colores Painted in aluminium bilayer or see colors.	1023L	348.60	377.00	362.00	419.00
	1023I				
	1023T				
Acero Inoxidable Stainless Steel	1023X	431.55	460.00	445.00	502.00

T 110 T 120x80 39,70 1 0,350 80

1029 - 1020

Mesa con estructura de acero pintado en los diferentes acabados de pintura o acero inoxidable con tubo de 80x80 mm. Tapa en los diferentes acabados.
 Table with steel structure painted in different finishes or Stainless Steel with pipe of 80x80 mm. Cover with the same finishes.



- Bicapa aluminizado(L) Bi-coat aluminized(L)
- Negro Texturizado (T) Textured Black (T)
- Blanco Mate (1) Mate White (1)

ESTRUCTURA FRAMEWORK	CÓDIGO CODE				
		COMPACTO COMPACT	COMPACTO D COMPACT DEC.	REGRESADO THICKNESS	MADERA WOOD
1029 Pintado en aluminio bicapa, o consultar colores Painted in aluminium bilayer or see colors.	1029L	314.00	342.00	323.00	357.00
	1029I				
	1029T				
Acero Inoxidable Stainless Steel	1029X	341.00	424.00	401.00	433.00

T 75 T 110x70 36 1 0,250 70

ESTRUCTURA FRAMEWORK	CÓDIGO CODE				
		COMPACTO COMPACT	COMPACTO D COMPACT DEC.	REGRESADO THICKNESS	MADERA WOOD
1020 Pintado en aluminio bicapa, o consultar colores Painted in aluminium bilayer or see colors.	1020L	336.00	365.00	350.00	406.00
	1020I				
	1020T				
Acero Inoxidable Stainless Steel	1020X	404.00	432.60	418.00	475.00

T 75 T 120x80 38,66 1 0,250 80

Madera (e:22mm) Wood - M

- MH MF MO MW

Regresado (e:40mm) Thicknesser (e:40mm) - G

- GB GN GZ GW

Compacto (e:10mm) Compact - C

- CB C6 CK CJ CT CU C3 CA CN

- CG CW CO CE

Compacto decorado (e:10mm) Compact - 2

- 2N 2B 2X

1003 - 1009

Mesa con estructura de acero pintado en los diferentes acabados de pintura o acero inoxidable con tubo de 80x80 mm. Tapa en los diferentes acabados.
 Table with steel structure painted in different finishes or Stainless Steel with pipe of 80x80 mm. Cover with the same finishes.



- Bicapa aluminizado(L) Bi-coat aluminized(L)
- Negro Texturizado (T) Textured Black (T)
- Blanco Mate (1) Mate White (1)

ESTRUCTURA FRAMEWORK	CÓDIGO CODE				
		COMPACTO COMPACT	COMPACTO D COMPACT DEC.	REGRESADO THICKNESS	MADERA WOOD
1003 Pintado en aluminio bicapa, o consultar colores Painted in aluminium bilayer or see colors.	1003L	273.00	305.00	283.00	315.00
	1003I				
	1003T				
Acero Inoxidable Stainless Steel	1003X	325.00	358.00	334.00	365.00

T 75 T 110x70 25,00 1 0,210 70

ESTRUCTURA FRAMEWORK	CÓDIGO CODE				
		COMPACTO COMPACT	COMPACTO D COMPACT DEC.	REGRESADO THICKNESS	MADERA WOOD
1009 Pintado en aluminio bicapa, o consultar colores Painted in aluminium bilayer or see colors.	1009L	285.00	313.00	298.00	354.00
	1009I				
	1009T				
Acero Inoxidable Stainless Steel	1009X	337.00	365.00	351.00	407.00

T 75 T 120x80 28,00 1 0,210 80

- Interiores/cubierto Indoor/cover
- Sólo en interiores Indoor
- Útil para exteriores Outdoor

Madera (e:22mm) Wood - M

- MH MF MO MW

Regresado (e:40mm) Thicknesser (e:40mm) - G

- GB GN GZ GW

Compacto (e:10mm) Compact - C

- CB C6 CK CJ CT CU C3 CA CN

- CG CW CO CE

Compacto decorado (e:10mm) Compact - 2

- 2N 2B 2X



0795 - 0797

Mesa con estructura de acero inoxidable o cromo con tubo de 76 mm. Tapa en los diferentes acabados.
Table with stainless steel or chrome structure with pipe of 76 mm. Cover in different finishes.



ESTRUCTURA FRAMEWORK	CÓDIGO CODE	COMPACTO	COMPACTO DECO
		COMPACT	COMPACT DECO
0795 Cromado Chrome	0795C	202.00	209.00
0795 Acero Inoxidable Stainless Steel	0795X	230.00	237.00

T 75 T 60 9 1 0,135 60

ESTRUCTURA FRAMEWORK	CÓDIGO CODE	COMPACTO	COMPACTO DECO
		COMPACT	COMPACT DECO
0797 Cromado Chrome	0797C	202.00	209.00
0797 Acero Inoxidable Stainless Steel	0797X	230.00	237.00

T 75 T 60x60 10 1 0,135 60

Interiores/cubierto *Indoor/cover*
 Útil para exteriores *Outdoor*

0792 - 0794

Mesa con estructura de acero inoxidable o cromo con tubo de 76 mm. Tapa en los diferentes acabados.
Table with stainless steel or chrome structure with pipe of 76 mm. Cover in different finishes.



ESTRUCTURA FRAMEWORK	CÓDIGO CODE	COMPACTO	COMPACTO D	REGRESADO	MADERA
		COMPACT	COMPACT DEC	THICKNESS	WOOD
0792 Cromado Chrome	0792C	217.00	224.00	•	247.00
0792 Acero Inoxidable Stainless Steel	0792X	242.00	243.00	•	271.00

T 75 T 70 10,30 1 0,077 70

ESTRUCTURA FRAMEWORK	CÓDIGO CODE	COMPACTO	COMPACTO D	REGRESADO	MADERA
		COMPACT	COMPACT DEC	THICKNESS	WOOD
0794 Cromado Chrome	0794C	217.00	224.00	223.00	259.00
0794 Acero Inoxidable Stainless Steel	0794X	242.00	243.00	250.00	285.00

T 75 T 70x70 11,80 1 0,077 70

Interiores/cubierto *Indoor/cover*
 Útil para exteriores *Outdoor*

Madera (e:22mm) *Wood - M*

MH MF MO MW

Regresado (e:40mm) *Thickness (e:40mm) - G*

GB GN GZ GW

NOTA: El Regresado se fabrican sólo en tapa cuadrada
NOTE: Thicknesser is manufactured in Squared top only

Compacto (e:10mm) *Compact - C*

CB C6 CK CJ CT CU C3 CA CN

CG CW CO CE

Compacto decorado (e:10mm) *Compact - 2*

2N 2B 2X

0790 - 0793

Mesa con estructura de acero inoxidable o cromo con tubo de 76 mm. Tapa en los diferentes acabados.
Table with stainless steel or chrome structure with pipe of 76 mm. Cover in different finishes.



ESTRUCTURA FRAMEWORK	CÓDIGO CODE	COMPACTO	COMPACTO D	REGRESADO	MADERA
		COMPACT	COMPACT DEC	THICKNESS	WOOD
0790 Cromado Chrome	0790C	241.00	245.00	•	276.00
0790 Acero Inoxidable Stainless Steel	0790X	267.00	270.00	•	301.00

T 75 T 80 11,50 1 0,077 80

ESTRUCTURA FRAMEWORK	CÓDIGO CODE	COMPACTO	COMPACTO D	REGRESADO	MADERA
		COMPACT	COMPACT DEC	THICKNESS	WOOD
0793 Cromado Chrome	0793C	241.00	245.00	334.00	277.00
0793 Acero Inoxidable Stainless Steel	0793X	267.00	293.00	259.00	301.00

T 75 T 80x80 13,96 1 0,077 80

Interiores/cubierto *Indoor/cover*
 Útil para exteriores *Outdoor*

Madera (e:22mm) *Wood - M*

MH MF MO MW

Regresado (e:40mm) *Thickness (e:40mm) - G*

GB GN GZ GW

NOTA: El Regresado se fabrican sólo en tapa cuadrada
NOTE: Thicknesser is manufactured in Squared top only

Compacto (e:10mm) *Compact - C*

CB C6 CK CJ CT CU C3 CA CN

CG CW CO CE

Compacto decorado (e:10mm) *Compact - 2*

2N 2B 2X

0698 - 0699

Mesa con estructura de acero inoxidable o cromo con tubo de 76 mm. Tapa en los diferentes acabados.
Table with stainless steel or chrome structure with pipe of 76 mm. Cover in different finishes.



ESTRUCTURA FRAMEWORK	CÓDIGO CODE	COMPACTO	COMPACTO DECO
		COMPACT	COMPACT DECO
0698 Cromado Chrome	0698C	214.00	221.00
0698 Acero Inoxidable Stainless Steel	0698X	236.00	244.00

T 110 T 60 14,00 1 0,067 60

ESTRUCTURA FRAMEWORK	CÓDIGO CODE	CRISTAL TRANSP.	CRISTAL OPACO	CRISTAL COLORES
		TRANSP. CRYSTAL	OPAQUE CRYSTAL	COLOURS CRYSTAL
0699 Cromado Chrome	0699C	280.00	297.00	307.00
0699 Acero Inoxidable Stainless Steel	0699X	303.00	320.00	330.00

T 110 T 70 16,00 1 0,067 70

Interiores/cubierto *Indoor/cover*
 Útil para exteriores *Outdoor*

Cristal (e:10mm) *Crystal (e:10mm) - Q*

QO QS QJ QU Q3 QN

1070 - 1071 - 1072

Mesa con estructura de acero inoxidable o cromo con tubo de 76 mm. Tapa en los diferentes acabados.
Table with stainless steel or chrome structure with pipe of 76 mm. Cover in different finishes.



ESTRUCTURA FRAMEWORK	CÓDIGO CODE	CRISTAL TRANSP. TRANSP. CRYSTAL	CRISTAL OPACO OPAQUE CRYSTAL	CRISTAL COLORES COLOURS CRYSTAL
		1070	Cromado Chrome	274.00
	Acero Inoxidable Stainless Steel	299.00	317.00	328.00

T 75 T 60 14,85 1 0,203 60

ESTRUCTURA FRAMEWORK	CÓDIGO CODE	CRISTAL TRANSP. TRANSP. CRYSTAL	CRISTAL OPACO OPAQUE CRYSTAL	CRISTAL COLORES COLOURS CRYSTAL
		1071	Cromado Chrome	295.00
	Acero Inoxidable Stainless Steel	320.00	344.00	357.00

T 75 T 70 16 1 0,203 70

ESTRUCTURA FRAMEWORK	CÓDIGO CODE	CRISTAL TRANSP. TRANSP. CRYSTAL	CRISTAL OPACO OPAQUE CRYSTAL	CRISTAL COLORES COLOURS CRYSTAL
		1072	Cromado Chrome	323.00
	Acero Inoxidable Stainless Steel	380.00	301.00	423.00

T 75 T 80 17,5 1 0,203 80

Interiores Indoor

Cristal (e:10mm) Crystal (e:10mm) - Q

QO QS QJ QU Q3 QN

0701

Mesa con estructura de acero inoxidable o cromo con tubo de 76 mm. Tapa en los diferentes acabados.
Table with stainless steel or chrome structure with pipe of 76 mm. Cover in different finishes.



ESTRUCTURA FRAMEWORK	CÓDIGO CODE	COMPACTO COMPACT	COMPACTO DECO COMPACT DECO
			Bicapa aluminizado Bi-coat aluminized
	Cromado Chrome	238.00	245.00
	Acero Inoxidable Stainless Steel	294.00	301.00

T 126 T 70-40 16,00 1 0,093 70 40

Útil para exteriores Outdoor

Compacto (e:10mm) Compact - C

CB C6 CK CJ CT CU C3 CA CN
CG CW CO CE

Compacto decorado (e:10mm) Compact - 2

2N 2B 2X

9988

Mesa con estructura de acero pintado en los diferentes acabados de pintura, con tubo de 30x30 mm. Tapa de madera de pino.
Table with steel structure painted in different finishes with pipe of 30x30 mm. Cover in pine wood.



ESTRUCTURA FRAMEWORK	CÓDIGO CODE	MADERA WOOD
Pintado en aluminio bicapa, o consultar colores Painted in aluminium bilayer or see colors.	9988L	161.00

T 113 T 60x60 12,12 1 0,211

60

Madera (e:20mm) Wood - M

MP

Interiores/cubierto Indoor / Cover



0630

Estructura de acero en pintura epoxi a elegir entre distintos colores (consultar apartado acabados).
Steel structure in epoxy paint to available in different colours (see section finishes).



Bicapa aluminizado(L)
Bi-coat aluminized(L)
Blanco (B)
White (1)
Negro (N)
Black (T)

ESTRUCTURA FRAMEWORK	CÓDIGO CODE	MELAMINA MELAMINE	COMPACTO COMPACT
Pintado en aluminio bicapa, o consultar colores <i>Painted in aluminium bilayer or see colors.</i>	0630L 0630B 0630N	65.00	106.00
Cromado <i>Chrome</i>	0630C	98.70	141.00

T 75 T 60 6,000 4 0,053 60

Interiores *Indoor*
 Útil para exteriores *Outdoor*

Compacto (e:10mm) Compact - C
CB C6 CK CJ CT CU C3 CA CN
CG CW CO CE
Melamina (e:19mm) Melamine - F
F

0654 - 0640 - 0644

Estructura de acero en pintura epoxi a elegir entre distintos colores (consultar apartado acabados).
Steel structure in epoxy paint to available in different colours (see section finishes).



Bicapa aluminizado(L)
Bi-coat aluminized(L)
Blanco (B)
White (1)
Negro (N)
Black (T)

ESTRUCTURA FRAMEWORK	CÓDIGO CODE	MELAMINA MELAMINE	COMPACTO COMPACT
0654	Pintado en aluminio bicapa, o consultar colores <i>Painted in aluminium bilayer or see colors.</i>	0654L 0654B 0654N	85.00 130.00
	Cromado <i>Chrome</i>	0654C	123.00 168.00

T 75 T 70X70 11,40 1 0,070 70

ESTRUCTURA FRAMEWORK	CÓDIGO CODE	MELAMINA MELAMINE	COMPACTO COMPACT
0640	Pintado en aluminio bicapa, o consultar colores <i>Painted in aluminium bilayer or see colors.</i>	0640L 0640B 0640N	90.00 155.00
	Cromado <i>Chrome</i>	0640C	128.00 193.00

T 75 T 80 12,00 1 0,079 80

ESTRUCTURA FRAMEWORK	CÓDIGO CODE	MELAMINA MELAMINE	COMPACTO COMPACT
0644	Pintado en aluminio bicapa, o consultar colores <i>Painted in aluminium bilayer or see colors.</i>	0644L 0644B 0644N	88.00 155.00
	Cromado <i>Chrome</i>	0644C	128.00 193.00

T 75 T 80X80 13,56 1 0,079 80

Compacto (e:10mm) Compact - C
CB C6 CK CJ CT CU C3 CA CN
CG CW CO CE
Melamina (e:19mm) Melamine - F
F

0612 - 0614 - 0615

Estructura de acero en pintura epoxi a elegir entre distintos colores (consultar apartado acabados).
Steel structure in epoxy paint to available in different colours (see section finishes).



Bicapa aluminizado(L)
Bi-coat aluminized(L)
Blanco (B)
White (1)
Negro (N)
Black (T)

ESTRUCTURA FRAMEWORK	CÓDIGO CODE	COMPACTO COMPACT	
0612	Bicapa aluminizado, blanco o negro <i>Bi-coat aluminized, white or black</i>	0612L 0612B 0612N	148.00

T 75 T 100X60 13,70 1 0,124 60

ESTRUCTURA FRAMEWORK	CÓDIGO CODE	COMPACTO COMPACT	
0614	Bicapa aluminizado, blanco o negro <i>Bi-coat aluminized, white or black</i>	0614L 0614B 0614N	174.00

T 75 T 110X70 16,00 1 0,081 70

ESTRUCTURA FRAMEWORK	CÓDIGO CODE	COMPACTO COMPACT	
0615	Bicapa aluminizado, blanco o negro <i>Bi-coat aluminized, white or black</i>	0615L 0615B 0615N	196.00

T 75 T 120X80 18,30 1 0,081 80

Interiores *Indoor*
 Útil para exteriores *Outdoor*

Compacto (e:10mm) Compact - C
CB C6 CK CJ CT CU C3 CA CN
CG CW CO CE

0693

Estructura de acero en pintura epoxi a elegir entre distintos colores (consultar apartado acabados).
Steel structure in epoxy paint to available in different colours (see section finishes).



ESTRUCTURA FRAMEWORK	CÓDIGO CODE	COMPACTO COMPACT	
0693	Pintado en aluminio bicapa, o consultar colores <i>Painted in aluminium bilayer or see colors.</i>	0693L 0693B 0693N	125.00
	Cromado <i>Chrome</i>	0693C	165.00

T 110 T 60 9,600 1 0,082 60

Interiores *Indoor*
 Útil para exteriores *Outdoor*

Compacto (e:10mm) Compact - C
CB C6 CK CJ CT CU C3 CA CN
CG CW CO CE

1081 - 1081/1

Mesa plegable con estructura de aluminio en pintura epoxi a elegir entre distintos colores (consultar apartado colores). Tubo de 65 mm triangulado.
Folding table with aluminium frame in epoxy paint to available in different colours. 65 mm tube.



ESTRUCTURA FRAMEWORK	CÓDIGO CODE	COMPACTO COMPACT		
1081 Pintado en aluminio bicapa, o consultar colores <i>Painted in aluminium bilayer or see colors.</i>	1081L	183.00	60	9,700
1081 Pintado en aluminio bicapa, o consultar colores <i>Painted in aluminium bilayer or see colors.</i>	1081L	183.00	60	10,700
1081/1 Pintado en aluminio bicapa, o consultar colores <i>Painted in aluminium bilayer or see colors.</i>	1081/1L	191.00	70	11,000
1081/1 Pintado en aluminio bicapa, o consultar colores <i>Painted in aluminium bilayer or see colors.</i>	1081/1L	191.00	70	12,500

T 110 T 60 9,700 1 0,054

Interiores <i>Indoor</i>
Útil para exteriores <i>Outdoor</i>
Plegable <i>Folding</i>

Compacto (e:10mm) Compact - C

CB	C6	CK	CJ	CT	CU	C3	CA	CN
CG	CW	CO	CE					

1082 - 1082/2

Mesa plegable con estructura de aluminio pintado con diferentes acabados
Folding table with painted in aluminium structure



ESTRUCTURA FRAMEWORK	CÓDIGO CODE	COMPACTO COMPACT		
1082 Pintado en aluminio bicapa, o consultar colores <i>Painted in aluminium bilayer or see colors.</i>	1082L	175.00	60	8,000
1082 Pintado en aluminio bicapa, o consultar colores <i>Painted in aluminium bilayer or see colors.</i>	1082L	175.00	60	9,000
1082/1 Pintado en aluminio bicapa, o consultar colores <i>Painted in aluminium bilayer or see colors.</i>	1082/1L	184.00	70	9,300
1082/1 Pintado en aluminio bicapa, o consultar colores <i>Painted in aluminium bilayer or see colors.</i>	1082/1L	184.00	70	10,800

T 75 T 70X70 10,8 1 0,037

Interiores <i>Indoor</i>
Útil para exteriores <i>Outdoor</i>
Plegable <i>Folding</i>

Compacto (e:10mm) Compact - C

CB	C6	CK	CJ	CT	CU	C3	CA	CN
CG	CW	CO	CE					

0627 - 0620 - 0628 - 0623 - 0625 - 0629

Mesa plegable con estructura de acero pintado en los diferentes acabados de pintura, con tubo de 28 mm. Tapa en los diferentes acabados.
Folding table with steel structure painted in different finishes with pipe of 28 mm. Cover in different finishes.



ESTRUCTURA FRAMEWORK	CÓDIGO CODE	MELAMINA MELAMINE	COMPACTO COMPACT	
0627 Pintado en aluminio bicapa, o consultar colores <i>Painted in aluminium bilayer or see colors.</i>	0627L 0627B 0627N	64.00	108.00	70
0620 Pintado en aluminio bicapa, o consultar colores <i>Painted in aluminium bilayer or see colors.</i>	0620L 0620B 0620N	64.00	108.00	70

T 75 T 70 8,400 2 0,165



ESTRUCTURA FRAMEWORK	CÓDIGO CODE	MELAMINA MELAMINE	COMPACTO COMPACT	
0628 Pintado en aluminio bicapa, o consultar colores <i>Painted in aluminium bilayer or see colors.</i>	0628L 0628B 0628N	69.00	134.00	80
0623 Pintado en aluminio bicapa, o consultar colores <i>Painted in aluminium bilayer or see colors.</i>	0623L 0623B 0623N	69.00	134.00	80

T 75 T 80 9,500 2 0,197



ESTRUCTURA FRAMEWORK	CÓDIGO CODE	MELAMINA MELAMINE	COMPACTO COMPACT	
0625 Pintado en aluminio bicapa, o consultar colores <i>Painted in aluminium bilayer or see colors.</i>	0625L 0625B 0625N	69.00	134.00	60 100
0629 Pintado en aluminio bicapa, o consultar colores <i>Painted in aluminium bilayer or see colors.</i>	0629L 0629B 0629N	99.00	177.00	80 120

T 75 T 100X60 12,00 2 0,225

T 75 T 120X80 16,30 1 0,292

Interiores <i>Indoor</i>
Útil para exteriores <i>Outdoor</i>
Plegable <i>Folding</i>

Compacto (e:10mm) Compact - C

CB	C6	CK	CJ	CT	CU	C3	CA	CN
CG	CW	CO	CE					

Melamina (e:19mm) Melamine - F

F

0715 - 0718 - 0710 - 0712

Mesa con estructura de acero pintado en los diferentes acabados de pintura, cromo o acero inoxidable, con tubo de 30 mm. Tapa en los diferentes acabados.
 Table with steel structure painted in different finishes, chrome or stainless steel, with pipe of 30 mm. Cover in different finishes.



ESTRUCTURA FRAMEWORK	CÓDIGO CODE	ACERO INOX STAINLESS STEEL	COMPACTO COMPACT
		Pintado en aluminio bicapa, o consultar colores <i>Painted in aluminium bilayer or see colors.</i>	0715L
Cromado <i>Chrome</i>	0715C	138.00	161.00
Acero Inoxidable <i>Stainless Steel</i>	0715X	215.00	235.00

T 75 T 70 9,500 1 0,126 70



ESTRUCTURA FRAMEWORK	CÓDIGO CODE	ACERO INOX STAINLESS STEEL	COMPACTO COMPACT
		Pintado en aluminio bicapa, o consultar colores <i>Painted in aluminium bilayer or see colors.</i>	0718L
Cromado <i>Chrome</i>	0718C	138.00	161.00
Acero Inoxidable <i>Stainless Steel</i>	0718X	215.00	235.00

T 75 T 70X70 10,910 1 0,126 70



ESTRUCTURA FRAMEWORK	CÓDIGO CODE	ACERO INOX STAINLESS STEEL	COMPACTO COMPACT
		Pintado en aluminio bicapa, o consultar colores <i>Painted in aluminium bilayer or see colors.</i>	0710L
Cromado <i>Chrome</i>	0710C	153.00	183.00
Acero Inoxidable <i>Stainless Steel</i>	0710X	229.00	260.00

T 75 T 80 12,00 1 0,135 80



ESTRUCTURA FRAMEWORK	CÓDIGO CODE	ACERO INOX STAINLESS STEEL	COMPACTO COMPACT
		Pintado en aluminio bicapa, o consultar colores <i>Painted in aluminium bilayer or see colors.</i>	0712L
Cromado <i>Chrome</i>	0712C	153.00	183.00
Acero Inoxidable <i>Stainless Steel</i>	0712X	229.00	260.00

T 75 T 80X80 13,070 1 0,135 80

Interiores/cubierto *Indoor/cover*
 Útil para exteriores *Outdoor*

Acero Inoxidable (e:21mm) *Stainless Steel - XX*



Compacto (e:10mm) *Compact - C*

CB	C6	CK	CJ	CT	CU	C3	CA	CN
CG	CW	CO	CE					

0740

Mesa con estructura de acero pintado en los diferentes acabados de pintura, cromo o acero inoxidable, con tubo de 30 mm. Tapa en los diferentes acabados.
 Table with steel structure painted in different finishes, chrome or stainless steel, with pipe of 30 mm. Cover in different finishes.



ESTRUCTURA FRAMEWORK	CÓDIGO CODE	COMPACTO COMPACT
		Pintado en aluminio bicapa, o consultar colores <i>Painted in aluminium bilayer or see colors.</i>
Cromado <i>Chrome</i>	0740C	211.00
Acero Inoxidable <i>Stainless Steel</i>	0740X	336.00

T 75 T 110X70 17,00 1 0,081 110

Sólo en interiores *Indoor*
 Útil para exteriores *Outdoor*

70
110

Compacto (e:10mm) *Compact - C*

CB	C6	CK	CJ	CT	CU	C3	CA	CN
CG	CW	CO	CE					

0694

Mesa con estructura de acero pintado en los diferentes acabados de pintura, cromo o acero inoxidable, con tubo de 30 mm. Tapa en los diferentes acabados.
 Table with steel structure painted in different finishes, chrome or stainless steel, with pipe of 30 mm. Cover in different finishes.



ESTRUCTURA FRAMEWORK	CÓDIGO CODE	COMPACTO COMPACT
		Pintado en aluminio bicapa, o consultar colores <i>Painted in aluminium bilayer or see colors.</i>
Cromado <i>Chrome</i>	0694C	145.00
Acero Inoxidable <i>Stainless Steel</i>	0694X	251.00

T 110 T 60 10,60 1 0,293 60

60

Compacto (e:10mm) *Compact - C*

CB	C6	CK	CJ	CT	CU	C3	CA	CN
CG	CW	CO	CE					

0605

Mesa con estructura de acero pintado en los diferentes acabados de pintura, cromo o acero inoxidable, con tubo de 30 mm. Tapa en los diferentes acabados.
Table with steel structure painted in different finishes, chrome or stainless steel, with pipe of 30 mm. Cover in different finishes.



ESTRUCTURA FRAMEWORK	CÓDIGO CODE	COMPACTO COMPACT
Pintado en aluminio bicapa, o consultar colores <i>Painted in aluminium bilayer or see colors.</i>	0605L 0605N	147.00
Cromado <i>Chrome</i>	0605C	159.60

T 75 T 70 10,10 4 0,600 70

Interiores/cubierto <i>Indoor/cover</i>
Útil para exteriores <i>Outdoor</i>

Compacto (e:10mm) Compact - C

CB C6 CK CJ CT CU C3 CA CN
CG CW CO CE

Compacto decorado (e:10mm) Compact - 2

2N 2B 2X

Bicapa aluminizado(L)
Bi-coat aluminized(L) Negro (N)
Black (T)

0608

Mesa con estructura de acero pintado en los diferentes acabados de pintura, cromo o acero inoxidable, con tubo de 30 mm. Tapa en los diferentes acabados.
Table with steel structure painted in different finishes, chrome or stainless steel, with pipe of 30 mm. Cover in different finishes.



ESTRUCTURA FRAMEWORK	CÓDIGO CODE	COMPACTO COMPACT
Pintado en aluminio bicapa, o consultar colores <i>Painted in aluminium bilayer or see colors.</i>	0608L 0608N	162.00
Cromado <i>Chrome</i>	0608C	178.00

T 75 T 80 11,70 4 1,200 80

Interiores/cubierto <i>Indoor/cover</i>
Útil para exteriores <i>Outdoor</i>

Compacto (e:10mm) Compact - C

CB C6 CK CJ CT CU C3 CA CN
CG CW CO CE

Compacto decorado (e:10mm) Compact - 2

2N 2B 2X

Bicapa aluminizado(L)
Bi-coat aluminized(L) Negro (N)
Black (T)

1000 - 1002 - 1004

Mesa con estructura de acero y base de aluminio pintado en los diferentes acabados de pintura. Tapa en los diferentes acabados.
Table with steel structure and aluminium base painted in different finishes. Cover in different finishes.



ESTRUCTURA FRAMEWORK	CÓDIGO CODE	COMPACTO COMPACT
1000 Pintado en aluminio bicapa, o consultar colores <i>Painted in aluminium bilayer or see colors.</i>	1000N	189.00

T 75 T 70x70 20,90 1 0,039 70

ESTRUCTURA FRAMEWORK	CÓDIGO CODE	COMPACTO COMPACT
1002 Pintado en aluminio bicapa, o consultar colores <i>Painted in aluminium bilayer or see colors.</i>	1002N	202.00

T 75 T 80 21,60 1 0,030 80

ESTRUCTURA FRAMEWORK	CÓDIGO CODE	COMPACTO COMPACT
1004 Pintado en aluminio bicapa, o consultar colores <i>Painted in aluminium bilayer or see colors.</i>	1004N	202.00

T 75 T 80x80 23,20 1 0,039 80

Interiores <i>Indoor</i>
Útil para exteriores <i>Outdoor</i>

Compacto (e:10mm) Compact - C

CB C6 CK CJ CT CU C3 CA CN
CG CW CO CE

1014 - 1012 - 1010

Mesa con estructura de acero y base de aluminio pintado en los diferentes acabados de pintura. Tapa en los diferentes acabados.
Table with steel structure and aluminium base painted in different finishes. Cover in different finishes.



ESTRUCTURA FRAMEWORK	CÓDIGO CODE	COMPACTO COMPACT
1014 Pintado en aluminio bicapa, o consultar colores <i>Painted in aluminium bilayer or see colors.</i>	1014N	192.00

T 75 T 70x70 23,30 1 0,030 70

ESTRUCTURA FRAMEWORK	CÓDIGO CODE	COMPACTO COMPACT
1012 Pintado en aluminio bicapa, o consultar colores <i>Painted in aluminium bilayer or see colors.</i>	1012N	204.00

T 75 T 80 23,70 1 0,039 80

ESTRUCTURA FRAMEWORK	CÓDIGO CODE	COMPACTO COMPACT
1010 Pintado en aluminio bicapa, o consultar colores <i>Painted in aluminium bilayer or see colors.</i>	1010N	204.00

T 75 T 80x80 25,30 1 0,039 80

Compacto (e:10mm) Compact - C

CB C6 CK CJ CT CU C3 CA CN
CG CW CO CE

Interiores <i>Indoor</i>
Útil para exteriores <i>Outdoor</i>

1040

Mesa con estructura de aluminio fundido, pintado en los diferentes acabados de pintura. Tapa en los diferentes acabados.
Table with structure molten painted aluminium, different finishes. Cover in different finishes.



ESTRUCTURA FRAMEWORK	CÓDIGO CODE	COMPACTO COMPACT
Pintado en aluminio bicapa, o consultar colores <i>Painted in aluminium bilayer or see colors.</i>	1040N	186.00

T 75 T 70X70 12,60 1 0,058 70

Interiores *Indoor*
 Útil para exteriores *Outdoor*

Compacto (e:10mm) Compact - C

CB	C6	CK	CJ	CT	CU	C3	CA	CN
CG	CW	CO	CE					

1050 - 1052 - 1054

Mesa con estructura de aluminio fundido, pintado en los diferentes acabados de pintura. Tapa en los diferentes acabados.
Table with structure molten painted aluminium, different finishes. Cover in different finishes.



ESTRUCTURA FRAMEWORK	CÓDIGO CODE	COMPACTO COMPACT
1050 Pintado en aluminio bicapa, o consultar colores <i>Painted in aluminium bilayer or see colors.</i>	1050N	215.00

T 75 T 70X70 13,90 1 0,055 70

ESTRUCTURA FRAMEWORK	CÓDIGO CODE	COMPACTO COMPACT
1052 Pintado en aluminio bicapa, o consultar colores <i>Painted in aluminium bilayer or see colors.</i>	1052N	238.00

T 75 T 80 14,50 1 0,067 80

ESTRUCTURA FRAMEWORK	CÓDIGO CODE	COMPACTO COMPACT
1054 Pintado en aluminio bicapa, o consultar colores <i>Painted in aluminium bilayer or see colors.</i>	1054N	238.00

T 75 T 80X80 16,10 1 0,067 80

Interiores *Indoor*
 Útil para exteriores *Outdoor*

Compacto (e:10mm) Compact - C

CB	C6	CK	CJ	CT	CU	C3	CA	CN
CG	CW	CO	CE					

0702

Mesa con estructura de acero pintado en los diferentes acabados de pintura o cromo, con tubo de 20 mm. Tapa en los diferentes acabados.
Table with steel structure painted in different finishes or chrome with pipe of 20 mm. Cover in different finishes.



ESTRUCTURA FRAMEWORK	CÓDIGO CODE	COMPACTO COMPACT	COMPACTO DECO DECORATED COMPACT
Pintado en aluminio bicapa, o consultar colores <i>Painted in aluminium bilayer or see colors.</i>	0702L 07021 0702T	112.00	119.00
Cromado <i>Chrome</i>	0702C	127.00	134.00

T 110 T 60 8,500 1 0,239 60

Interiores *Indoor*
 Útil para exteriores *Outdoor*

Compacto (e:10mm) Compact - C

CB	C6	CK	CJ	CT	CU	C3	CA	CN
CG	CW	CO	CE					

Compacto decorado (e:10mm) Compact - 2

2N	2B	2X
----	----	----

- Bicapa aluminizado(L)
Bi-coat aluminized(L)
- Blanco Mate (1)
Mate White (1)
- Negro Texturizado (T)
Textured Black (T)

0700

Mesa con estructura de aluminio y base de acero inoxidable. Tapa en los diferentes acabados.
Table with aluminium structure and stainless steel base. Cover in different finishes.



ESTRUCTURA FRAMEWORK	CÓDIGO CODE	ACERO INOX STAINLESS STEEL	COMPACTO COMPACT	COMPACTO DECO DECORATED COMPACT
Tubo de Aluminio y base en acero inoxidable <i>Aluminium tube and Stainless Steel base.</i>	0700X	265.00	276.00	282.00

T 110 T 60 8,300 1 0,070 60

Interiores *Indoor*
 Útil para exteriores *Outdoor*

Compacto (e:10mm) Compact - C

CB	C6	CK	CJ	CT	CU	C3	CA	CN
CG	CW	CO	CE					

Acero Inoxidable (e:21mm) Stainless Steel - XX

XX

Compacto decorado (e:10mm) Compact - 2

2N	2B	2X
----	----	----

0801 - 0802 - 0803 - 0804

Mesa con estructura de acero inoxidable o cromo con tubo de 76 mm. Tapa en los diferentes acabados.
Table with stainless steel structure or chromed with tube of 76 mm. Top cover with the same finished.



ESTRUCTURA FRAMEWORK	CÓDIGO CODE	COMPACTO	CRISTAL TR.	CRISTAL OP.	CRISTAL COL.	60
		COMPACT	TRASP. CRYSTAL	OPAQ. CRYSTAL	COL. CRYSTAL	
0801 Cromado Chrome	0801C	198.00	256.00	274.00	285.00	60
	0801X	226.00	283.00	301.00	312.00	
0802 Cromado Chrome	0802C	198.00	•	•	•	60
	0802X	226.00	•	•	•	

T 42 T 60x60 kg 7,700 1 0,052

ESTRUCTURA FRAMEWORK	CÓDIGO CODE	COMPACTO	CRISTAL TR.	CRISTAL OP.	CRISTAL COL.	70
		COMPACT	TRASP. CRYSTAL	OPAQ. CRYSTAL	COL. CRYSTAL	
0803 Cromado Chrome	0803C	211.00	277.00	300.00	314.00	70
	0803X	338.00	304.00	327.00	341.00	
0804 Cromado Chrome	0804C	211.00	•	•	•	70
	0804X	238.00	•	•	•	

T 42 T 70x70 kg 9,200 1 0,077

Compacto (e:10mm) Compact - C
 CB C6 CK CJ CT CU C3 CA CN CG CW CO CE
Cristal (e:10mm) Crystal (e:10mm) - Q
 QO QS QJ QU Q3 QN

Sólo en interiores Indoor
Útil para exteriores Outdoor

1001 - 1011

Mesa con estructura de acero pintado en los diferentes acabados de pintura con tubo de 80x80 mm. Tapa en los diferentes acabados.
Table with steel structure painted in the different ones finished, with tube of 80x80 mm. Top cover with the same finished.



ESTRUCTURA FRAMEWORK	CÓDIGO CODE	COMPACTO	COMPACTO D.	REGRUESADO	MADERA	70
		COMPACT	COMPACT DEC.	THICKNESS	WOOD	
1001 Pintado en aluminio bicapa, o consultar colores. Painted in aluminium bilayer or see colors.	1001L	262.00	295.00	271.00	305.00	110
	1001X	311.00	344.00	314.00	353.00	
1011 Bicapa aluminizado Bi-coat aluminized	1011L	274.00	302.00	288.00	344.00	80
	1011X	323.00	352.00	337.00	394.00	

T 42 T 120x70 kg 28,00 1 0,098

Interiores/cubierto Indoor/cover
Sólo en interiores Indoor
Útil para exteriores Outdoor

Regruesado (e:40mm) Thicknesser (e:40mm) - G
 GB GN GZ GW
Madera (e:22mm) Wood - M
 MH MF MO MW

Compacto (e:10mm) Compact - C
 CB C6 CK CJ CT CU C3 CA CN CG CW CO CE

Compacto decorado (e:10mm) Compact - 2
 2N 2B 2X

9995

Mesa cubitera con estructura de acero termolacado, soporte de cubitera en compacto fenólico y una cubitera de policarbonato translúcido de 33 cm Ø.
Ice bucket table with thermo-lacquered steel structure, ice bucket holder in a phenolic compact and a translucent polycarbonate ice bucket of 33 cm Ø.



ESTRUCTURA FRAMEWORK	CÓDIGO CODE	COMPACTO COMPACT
Pintado en aluminio bicapa, o consultar colores Painted in aluminium bilayer or see colors.	9995L	162.00

T 110 T 60 kg 12,44 1 0,239 60

Útil para exteriores Outdoor

Compacto Compact - C
 CB C6 CK CJ CT CU C3 CA CN CG CW CO CE



0616

Mesa plegable con estructura de acero termolacado. Tapa de compacto fenólico a elegir entre los diferentes acabados.
Folding table with steel structure painted in different finishes. Cover in different finishes.



ESTRUCTURA FRAMEWORK	CÓDIGO CODE	COMPACTO COMPACT
Pintado en aluminio bicapa, o consultar colores <i>Painted in aluminium bilayer or see colors.</i>	0616L	76.00

T 110 T 60 9,7,40 1 0,054 60

Útil para exteriores Outdoor

Compacto Compact - C

CB C6 CK CJ CT CU C3 CA CN CG CW CO CE

0671

Mesa con estructura de aluminio. Tapa en los diferentes acabados.
Table with aluminium structure. Cover in different finishes.



ESTRUCTURA FRAMEWORK	CÓDIGO CODE	COMPACTO COMPACT
Aluminio <i>Aluminium.</i>	0671	139.00

T 110 T 60 9,9,500 1 0,054 60

Interiores Indoor

Compacto Compact - C

CB C6 CK CJ CT CU C3 CA CN CG CW CO CE

0721

Mesa plegable con estructura de acero pintado en los diferentes acabados de pintura. Tapa en los diferentes acabados.
Folding table with steel structure painted in different finishes. Cover in different finishes.



ESTRUCTURA FRAMEWORK	CÓDIGO CODE	COMPACTO COMPACT
Pintado en aluminio bicapa, o consultar colores <i>Painted in aluminium bilayer or see colors.</i>	0721L	95.00

T 110 T 60 9,9,680 1 0,054 60

Útil para exteriores Outdoor

Compacto Compact - C

CB C6 CK CJ CT CU C3 CA CN CG CW CO CE

COMPLEMENTOS DE EXTERIOR

EXTERIOR COMPLEMENTS

Separadores | Sombrillas | Vallas | Estufas

Terrace dividers | Umbrellas | Fences | Stoves

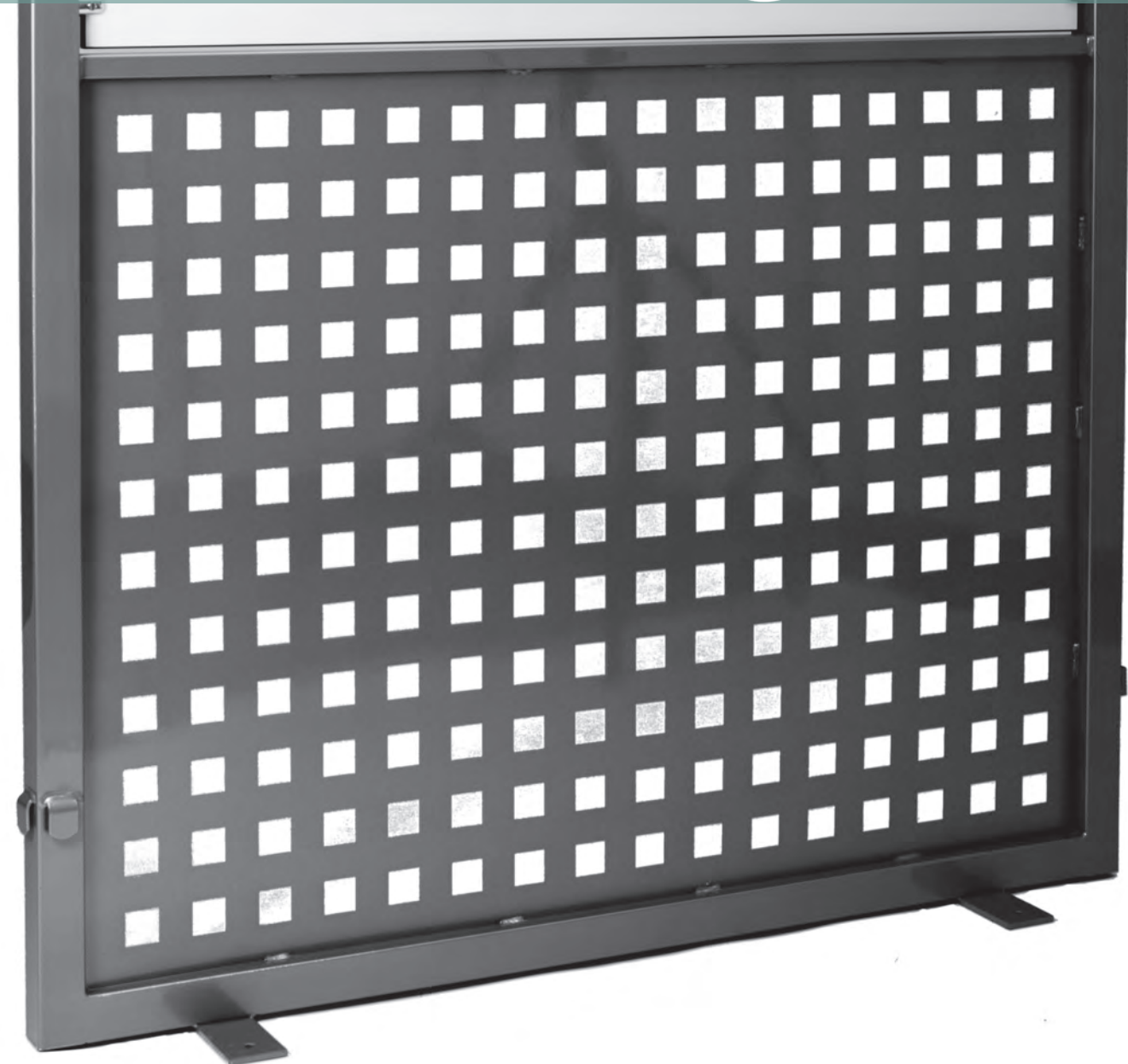
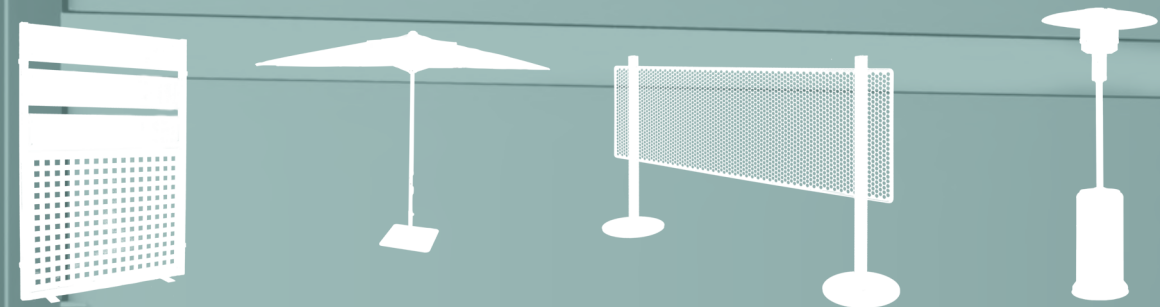

8006



Estructura de acero compuesta de tubo 40x40 mm, chapa 1,5 mm de espesor, parte superior de láminas de compacto.
Steel structure composed of 40x40 mm tube, steel 1.5 mm thickness, The top is of compact sheets.

ESTRUCTURA FRAMEWORK	CÓDIGO CODE	COMPACTO COMPACT
Gris bicapa, Blanco Mate, Negro mate o Marrón mate <i>Gray Bi-coat, Mate White, Mate black or Mate brown</i>	8006	191.10
Útil para exteriores Outdoor		

8016



Estructura de acero compuesta de tubo 40x40 mm, chapa 1,5 mm de espesor, parte superior de vidrio templado 990x680x5 mm.
Steel structure composed of 40x40 mm tube, steel 1.5 mm thickness, The top is of Tempered glass 990x680x5 mm.

ESTRUCTURA FRAMEWORK	CÓDIGO CODE	CRISTAL TEMPLADO TEMPERED GLASS
Gris bicapa, Blanco Mate, Negro mate o Marrón mate <i>Gray Bi-coat, Mate White, Mate black or Mate brown</i>	8016	191.10
Útil para exteriores Outdoor		

8007



Estructura de acero compuesta de tubo 40x40 mm, chapa 1,5 mm de espesor, parte superior de láminas de compacto.
Steel structure composed of 40x40 mm tube, steel 1.5 mm thickness, The top is of compact sheets.

ESTRUCTURA FRAMEWORK	CÓDIGO CODE	COMPACTO COMPACT
Gris bicapa, Blanco Mate, Negro mate o Marrón mate <i>Gray Bi-coat, Mate White, Mate black or Mate brown</i>	8007	191.10
Útil para exteriores Outdoor		

8008



Estructura de acero compuesta de tubo 40x40 mm, chapa 1,5 mm de espesor, parte superior de vidrio templado 990x680x5 mm.
Steel structure composed of 40x40 mm tube, steel 1.5 mm thickness, The top is of Tempered glass 990x680x5 mm.

ESTRUCTURA FRAMEWORK	CÓDIGO CODE	CRISTAL TEMPLADO TEMPERED GLASS
Gris bicapa, Blanco Mate, Negro mate o Marrón mate <i>Gray Bi-coat, Mate White, Mate black or Mate brown</i>	8008	191.10
Útil para exteriores Outdoor		

8002



Estructura de acero acabado en pintura de poliéster, compuesta de 2 tubos 50x1x920 mm, chapa perforada 1500x500x1,5 mm, 2 discos de 300 Ø x 6 mm.
Steel structure finished in polyester paint, composed of 2 tubes 50x1x920 mm, perforated sheet 1500x500x1,5 mm, 2 disks 300 Ø x 6 mm.

ESTRUCTURA FRAMEWORK	CÓDIGO CODE	ACERO STEEL
Gris Bicapa, Blanco Mate, Negro mate o Marrón mate <i>Gray Bi-coat, Mate White, Mate black or Mate brown</i>	8002	123.90
Útil para exteriores Outdoor		

8012

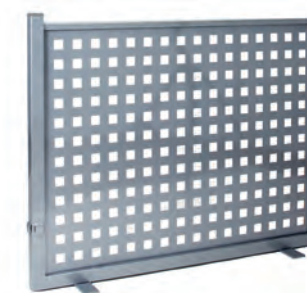

Estructura de acero compuesta de tubo 40x40 mm, chapa 1,5 mm de espesor.
Steel structure composed of 40x40 mm tube, steel 1.5 mm thickness.

ESTRUCTURA FRAMEWORK	CÓDIGO CODE	ACERO STEEL
Gris Bicapa, Blanco Mate, Negro mate o Marrón mate <i>Gray Bi-coat, Mate White, Mate black or Mate brown</i>	8012	126.00
Útil para exteriores Outdoor		

8013



Estructura de acero compuesta de tubo 40x40 mm, chapa 1,5 mm de espesor.
Steel structure composed of 40x40 mm tube, steel 1.5 mm thickness.

ESTRUCTURA FRAMEWORK	CÓDIGO CODE	ACERO - COMPACTO STEEL - COMPACT
Gray Bicapa, Blanco Mate, Negro mate o Marrón mate <i>Bi-coat, Mate White, Mate black or Mate brown</i>	8013	126.00
Útil para exteriores Outdoor		

8014



Estufa calentador de exterior. Funciona con gas propano o gas butano.
Outdoor external heater. It works with propane gas or butane gas.

ESTRUCTURA FRAMEWORK	CÓDIGO CODE	ESTUFA STOVE
Estufa calentador de patio <i>Stove heater of court</i>	8014	165.00
Útil para exteriores Outdoor		

8005



Base de acero pintado de 6 mm de espesor. Tubo de acero pintado de 1,5 mm de espesor.
Painted steel base 6 mm thickness. Steel tube painted 1.5 mm thickness.

ESTRUCTURA FRAMEWORK	CÓDIGO CODE
Base parasol pintado en los diferentes acabados de pintura Base parasol ended in the different ones ended of painting	8005

BASE PARASOL UMBRELLA BASE
58.59

62,5x62,5 35 -0,5 17,500 1 0,120 Útil para exteriores Outdoor

8010



Parasol de aluminio pintado en blanco con 8 varillas de aluminio. Tela 100 % poliéster 200 gr/m. 3 metros de diámetro.
Umbrella of aluminium painted in white with 8 rods of aluminium. Fabric 100 % polyester 200 gr/m. Diameter of 3 meters

ESTRUCTURA FRAMEWORK	CÓDIGO CODE
Aluminio pintado en blanco con 8 varillas de aluminio Aluminium painted in white with 8 rods of aluminium.	8010

POLIESTER POLYESTER
157.00

T 2,55 T 3 m 47 6,500 1 0,120

Útil para exteriores Outdoor

8011



Parasol de aluminio pintado en blanco con 8 varillas de aluminio. Tela 100 % poliéster 200 gr/m. 3x3 metros.
Umbrella of aluminium painted in white with 8 rods of aluminium. Fabric 100 % polyester 200 gr/m. 3x3 meters.

ESTRUCTURA FRAMEWORK	CÓDIGO CODE
Aluminio pintado en blanco con 8 varillas de aluminio Aluminium painted in white with 8 rods of aluminium.	8011

POLIESTER POLYESTER
165.00

T 2,55 T 3x3 47 11,000 1 0,120

Útil para exteriores Outdoor

8015



Parasol de aluminio pintado en blanco con 8 varillas de aluminio. Tela 100 % textilene 2,5x2,5 metros.
Umbrella of aluminium painted in white with 8 rods of aluminium. Fabric 100 % textilene 2,5x2,5 meters.

ESTRUCTURA FRAMEWORK	CÓDIGO CODE
Aluminio pintado en blanco con 8 varillas de aluminio Aluminium painted in white with 8 rods of aluminium.	8015

TEXTILENE TEXTILENE
220.00

T 2,55 T 2,5x2,5 47 8,590 1 0,120

Útil para exteriores Outdoor

MOBILIARIO DE MADERA

WOODEN FURNITURE

Sillas | Taburetes | Mesas

Chairs | Stools | Tables



0530



Taburete de madera con refuerzos en acero (diferentes acabados).
Wooden stool with steel reinforcements (different finishes)

ESTRUCTURA <i>FRAMEWORK</i>	CÓDIGO <i>CODE</i>	MADERA <i>WOOD</i>
Madera <i>Wood</i>	0530M	78

T 48	T 35X35	kg 5,70		
------	---------	---------	--	--

Sólo en interiores *Indoor*

Madera M

MH MF MO

0532



Taburete de madera con refuerzos en acero (diferentes acabados).
Wooden stool with steel reinforcements (different finishes)

ESTRUCTURA <i>FRAMEWORK</i>	CÓDIGO <i>CODE</i>	MADERA <i>WOOD</i>
Madera <i>Wood</i>	0532M	82

T 74	T 35X35	kg 7		
------	---------	------	--	--

Sólo en interiores *Indoor*

Madera M

MH MF MO

0536



Taburete de madera con refuerzos en acero (diferentes acabados).
Wooden stool with steel reinforcements (different finishes)

ESTRUCTURA <i>FRAMEWORK</i>	CÓDIGO <i>CODE</i>	MADERA <i>WOOD</i>
Madera <i>Wood</i>	0536M	124.50

H 101	H 35X35	kg 8,70		
-------	---------	---------	--	--

Sólo en interiores *Indoor*

Madera M

MH MF MO

0739 - 0839



Mesa de madera con refuerzos en acero (diferentes acabados).
Wooden table with steel reinforcements (different finishes)

	ESTRUCTURA <i>FRAMEWORK</i>	CÓDIGO <i>CODE</i>	MADERA <i>WOOD</i>	
0739	Madera <i>Wood</i>	0739M	158	70 70
0839	Madera <i>Wood</i>	0839M	169	80 80

T 74	T 70X70	kg 15,35		
------	---------	----------	--	--

Sólo en interiores *Indoor*

Madera M

MH MF MO

1179



Estructura de madera de haya con asiento en polipiel.
Beech wood structure with seat leatherette.

ESTRUCTURA <i>FRAMEWORK</i>	CÓDIGO <i>CODE</i>	MADERA <i>WOOD</i>	MADERA <i>WOOD</i>	TAPIZADO <i>UPHOLSTERED</i>	TAPIZADO <i>UPHOLSTERED</i>
		SERIE N	SERIE E	S.N	S.E
Madera <i>Wood</i>	1179M	86.50	106.70	89.30	109.00

H 91	H 48	H 42	H 45	kg 5,70		
------	------	------	------	---------	--	--

Sólo en interiores *Indoor*

Madera Serie E *Wood Series E - M*

MB MN MG

Madera Serie N *Wood Series N - M*

MH MF MO MW

Polipiel *Imitation Leather - L*

LK LB LA LC LL LJ LN L3 LU



9011

Estructura en madera de haya con asiento chapado en madera, tela o polipiel.
Beech wood structure with seat in wood, fabric or polyskin.



ESTRUCTURA FRAMEWORK	CÓDIGO CODE	MADERA WOOD	MADERA SERIE N WOOD	MADERA SERIE E WOOD	TAPIZADO UPHOLSTERED	TAPIZADO S. N UPHOLSTERED	TAPIZADO S. E
Madera Wood	9011	115.45	142.50	105.25	146.71		

H91 | W45 | H44,5 | P46,5 | Kg 6,10 | 2 | 0,30

Sólo en interiores *Indoor*

Madera Serie E *Wood Series E - M*

MB MN MG

Madera Serie N *Wood Series N - M*

MH MF MO MW

Polipiel *Imitation Leather - L*

LK LB LA LC LL LJ LN L3 LU

Tela *Fabric - T*

T102 T104 T105 T107 T109 T112 T116 T117

9019

Estructura en madera de haya con asiento chapado en madera, tela o polipiel.
Beech wood structure with seat in wood, fabric or polyskin.



ESTRUCTURA FRAMEWORK	CÓDIGO CODE	MADERA WOOD	MADERA SERIE N WOOD	MADERA SERIE E WOOD	TAPIZADO UPHOLSTERED	TAPIZADO S. N UPHOLSTERED	TAPIZADO S. E
Madera Wood	9019	118.70	146.50	122.50	150.95		

H88 | W47 | H40,5 | P41,5 | Kg 6,7 | 2 | 0,30

Sólo en interiores *Indoor*

Madera Serie N *Wood Series N - M*

MH MF MO MW

Madera Serie E *Wood Series E - M*

MB MN MG

Polipiel *Imitation Leather - L*

LK LB LA LC LL LJ LN L3 LU

9008

Estructura en madera de haya con asiento chapado en madera, tela o polipiel.
Beech wood structure with seat in wood, fabric or polyskin.



ESTRUCTURA FRAMEWORK	CÓDIGO CODE	MADERA WOOD	MADERA SERIE N WOOD	MADERA SERIE E WOOD	TAPIZADO UPHOLSTERED	TAPIZADO S. N UPHOLSTERED	TAPIZADO S. E
Madera Wood	9008	101.40	125.15	103.70	128.20		

H88 | W47,5 | H41 | P42 | Kg 5,5 | 2 | 0,30

Sólo en interiores *Indoor*

Madera Serie N *Wood Series N - M*

MH MF MO MW

Madera Serie E *Wood Series E - M*

MB MN MG

Polipiel *Imitation Leather - L*

LK LB LA LC LL LJ LN L3 LU

Tela *Fabric - T*

T102 T104 T105 T107 T109 T112 T116 T117

9007

Estructura en madera de haya con asiento chapado en madera, tela o polipiel.
Beech wood structure with seat in wood, fabric or polyskin.



ESTRUCTURA FRAMEWORK	CÓDIGO CODE	MADERA WOOD	MADERA SERIE N WOOD	MADERA SERIE E WOOD	TAPIZADO UPHOLSTERED	TAPIZADO S. N UPHOLSTERED	TAPIZADO S. E
Madera Wood	9007	92.25	113.80	94.60	116.70		

H88 | W48 | H42 | P40,5 | Kg 6 | 2 | 0,30

Sólo en interiores *Indoor*

Madera Serie N *Wood Series N - M*

MH MF MO MW

Madera Serie E *Wood Series E - M*

MB MN MG

Polipiel *Imitation Leather - L*

LK LB LA LC LL LJ LN L3 LU

Tela *Fabric - T*

T102 T104 T105 T107 T109 T112 T116 T117

9023

Estructura en madera de haya con asiento chapado en madera, tela o polipiel.
Beech wood structure with seat in wood, fabric or polyskin.



ESTRUCTURA FRAMEWORK	CÓDIGO CODE	MADERA WOOD	MADERA SERIE N WOOD	MADERA SERIE E WOOD	TAPIZADO UPHOLSTERED	TAPIZADO S. N UPHOLSTERED	TAPIZADO S. E
Madera Wood	9023	104.75	129.30	107.30	132.30		

H88 | W46 | H42 | P41 | Kg 5,5 | 2 | 0,30

Sólo en interiores *Indoor*

Madera Serie N *Wood Series N - M*

MH MF MO MW

Madera Serie E *Wood Series E - M*

MB MN MG

Polipiel *Imitation Leather - L*

LK LB LA LC LL LJ LN L3 LU

Tela *Fabric - T*

T102 T104 T105 T107 T109 T112 T116 T117

9013

Estructura de madera de haya con asiento en tela o polipiel.
Beech wood structure with seat draped in fabric or polyskin.



ESTRUCTURA FRAMEWORK	CÓDIGO CODE	TAPIZADO UPHOLSTERED	TAPIZADO S. N UPHOLSTERED	TAPIZADO S. E
Madera Wood	9013	112.00	112.00	

Madera Serie N *Wood Series N - M*

MH MF MO MW

Madera Serie E *Wood Series E - M*

MB MN MG

Polipiel *Imitation Leather - L*

LK LB LA LC LL LJ LN L3 LU

Tela *Fabric - T*

T102 T104 T105 T107 T109 T112 T116 T117

Sólo en interiores *Indoor*

1579



Estructura de madera de haya con asiento en polipiel.
Beech wood structure with seat leatherette.

ESTRUCTURA FRAMEWORK	CÓDIGO CODE	MADERA WOOD	MADERA WOOD	TAPIZADO UPHOLSTERED	TAPIZADO UPHOLSTERED
		SERIE N	SERIE E	S. N	S. E
Madera <i>Wood</i>	1579	97.60	119.00	99.80	123.15

h101	h78	h38	h37	kg 6	2	0,31
------	-----	-----	-----	------	---	------

Sólo en interiores *Indoor*

Madera Serie E *Wood Series E - M*

MB MN MG

Madera Serie N *Wood Series N - M*

MH MF MO MW

Polipiel *Imitation Leather - L*

LK LB LA LC LL LJ LN L3 LU

Tela *Fabric - T*

T102 T104 T105 T107 T109 T112 T116 T117

9500



Taburete en madera de haya con asiento chapado en madera, tela o polipiel.
Stool in beech wood, seat in veneered wood, fabric or polyskin.

ESTRUCTURA FRAMEWORK	CÓDIGO CODE	MADERA WOOD	MADERA WOOD	TAPIZADO UPHOLSTERED	TAPIZADO UPHOLSTERED
		SERIE N	SERIE E	S. N	S. E
Madera <i>Wood</i>	9500	132.20	163.10	133.15	164.90

h106,5	h76	h40	h37,5	kg 6,6	1	0,31
--------	-----	-----	-------	--------	---	------

Sólo en interiores *Indoor*

Madera Serie N *Wood Series N - M*

MH MF MO MW

Madera Serie E *Wood Series E - M*

MB MN MG

Polipiel *Imitation Leather - L*

LK LB LA LC LL LJ LN L3 LU

Tela *Fabric - T*

T102 T104 T105 T107 T109 T112 T116 T117

9501



Taburete en madera de haya con asiento chapado en madera, tela o polipiel.
Stool in beech wood, seat in veneered wood, fabric or polyskin.

ESTRUCTURA FRAMEWORK	CÓDIGO CODE	MADERA WOOD	MADERA WOOD	TAPIZADO UPHOLSTERED	TAPIZADO UPHOLSTERED
		SERIE N	SERIE E	S. N	S. E
Madera <i>Wood</i>	9501	107.80	133.10	110.50	136.40

h100,3	h76	h35	h35,5	kg 6,6	2	0,31
--------	-----	-----	-------	--------	---	------

Sólo en interiores *Indoor*

Madera Serie N *Wood Series N - M*

MH MF MO MW

Madera Serie E *Wood Series E - M*

MB MN MG

Polipiel *Imitation Leather - L*

LK LB LA LC LL LJ LN L3 LU

Tela *Fabric - T*

T102 T104 T105 T107 T109 T112 T116 T117

9523



Taburete en madera de haya con asiento chapado en madera, tela o polipiel.
Stool in beech wood, seat in veneered wood, fabric or polyskin.

ESTRUCTURA FRAMEWORK	CÓDIGO CODE	MADERA WOOD	MADERA WOOD	TAPIZADO UPHOLSTERED	TAPIZADO UPHOLSTERED
		SERIE N	SERIE E	S. N	S. E
Madera <i>Wood</i>	9523	110.80	136.10	113.50	139.40

h100,3	h76	h35	h35,5	kg 6,6	2	0,31
--------	-----	-----	-------	--------	---	------

Sólo en interiores *Indoor*

Madera Serie N *Wood Series N - M*

MH MF MO MW

Madera Serie E *Wood Series E - M*

MB MN MG

Polipiel *Imitation Leather - L*

LK LB LA LC LL LJ LN L3 LU

Tela *Fabric - T*

T102 T104 T105 T107 T109 T112 T116 T117

3062 - 3162



Estructura en madera de haya, tapa de aglomerado 19 mm de grosor chapado en haya.
Structure in beech wood, chipboard table top 19 mm thick beech veneer.

ESTRUCTURA FRAMEWORK	CÓDIGO CODE	AGLOMERADO CHIPBOARD
3062 Madera de haya <i>Beech wood</i>	3062	251.80

h110	h70 x 70	kg 21,5	1	0,13	70
------	----------	---------	---	------	----

ESTRUCTURA FRAMEWORK	CÓDIGO CODE	AGLOMERADO CHIPBOARD
3162 Madera de haya <i>Beech wood</i>	3162	270.30

h110	h80 x 80	kg 29	1	0,13	80
------	----------	-------	---	------	----

Sólo en interiores *Indoor*

Madera Serie E *Wood Series E - M*

MB MN MG

Madera Serie N *Wood Series N - M*

MH MF MO MW

3050 - 3051 - 3052



Mesa completa de madera lacada en nogal, cerezo o wengé.
Solid wood table lacquered in walnut, cherry-tree or wenge.

ESTRUCTURA FRAMEWORK	CÓDIGO CODE	MADERA WOOD
3050 Madera lacada: cerezo, nogal o wengé <i>Lacquered wood legs: cherry, walnut or wenge</i>	3050	132.40
3051 Madera lacada: cerezo, nogal o wengé <i>Lacquered wood legs: cherry, walnut or wenge</i>	3051	125.00
3052 Madera lacada: cerezo, nogal o wengé <i>Lacquered wood legs: cherry, walnut or wenge</i>	3052	112.50

h76	h90 x 90	kg 26,00	1	0,099
-----	----------	----------	---	-------

Madera (e:22mm) *Wood - M*

MF MO MW

0725 - 0825 - 0925



Estructura en madera de haya, tapa de aglomerado 30 mm de grosor chapado en haya.
Structure in beech wood, chipboard table top 30 mm thick beech veneer.

ESTRUCTURA FRAMEWORK	CÓDIGO CODE	AGLOMERADO CHIPBOARD	
0725 Madera de haya Beech wood	0725	CONSULTAR	70 70

74,5	70 x 70	21	1	0,10
------	---------	----	---	------

ESTRUCTURA FRAMEWORK	CÓDIGO CODE	AGLOMERADO CHIPBOARD	
0825 Madera de haya Beech wood	0825	CONSULTAR	80 80

74,5	80 x 80	28	1	0,13
------	---------	----	---	------

ESTRUCTURA FRAMEWORK	CÓDIGO CODE	AGLOMERADO CHIPBOARD	
0925 Madera de haya Beech wood	0925	CONSULTAR	90 90

74,5	90 x 90	31,00	1	0,16
------	---------	-------	---	------

Sólo en interiores *Indoor*

Madera Serie N *Wood Series N - M*

MH MF MO MW

Madera Serie E *Wood Series E - M*

MB MN MG

3060



Estructura en madera de pino, tapa de aglomerado 19 mm de grosor chapado en pino.
Pata de pino maciza 5 x 58 mm.
Structure in beech wood, chipboard table top 19 mm thick pine veneer.
Solid pine leg 58 x 58 mm.

ESTRUCTURA FRAMEWORK	CÓDIGO CODE	AGLOMERADO CHIPBOARD			
Madera de haya Beech wood	3060	163.00	174.00	183.00	204.00

Sólo en interiores <i>Indoor</i>	70	80	90	80
	70	80	90	120

74	70x70	15	1	0,099
----	-------	----	---	-------

Madera Serie N *Wood Series N - M*

MH MF MO MW

Madera Serie E *Wood Series E - M*

MB MN MG

3061



Estructura en madera de haya, tapa de aglomerado 30 mm de grosor chapado en haya.
Pata de haya maciza 55 x 55 mm.
Structure in beech wood, chipboard table top 30 mm thick beech veneer.
Solid beech leg 55 x 55 mm.

ESTRUCTURA FRAMEWORK	CÓDIGO CODE	MADERA WOOD			
Madera de haya Beech wood	3061	183.00	196.20	221.00	246.20

Sólo en interiores <i>Indoor</i>	70	80	90	80
	70	80	90	120

75	70 x 70	20,8	1	0,10
----	---------	------	---	------

Madera Serie N *Wood Series N - M*

MH MF MO MW

Madera Serie E *Wood Series E - M*

MB MN MG

3015 - 3020 - 3025 - 3030 - 3035

Mesa con estructura de madera de haya. Tapa en compacto.
Table with beech wood structure. Compact Table top.



Sólo en interiores *Indoor*

Compacto (e:10mm) *Compact - C*

CW CO CE

ESTRUCTURA FRAMEWORK	CÓDIGO CODE	COMPACTO COMPACT
3015 Tapa compacto con patas de madera lacada Table top with lacquered wood legs	3015	203.50

76	68x68	18,20	1	0,060	70
----	-------	-------	---	-------	----

ESTRUCTURA FRAMEWORK	CÓDIGO CODE	COMPACTO COMPACT
3020 Tapa compacto con patas de madera lacada Table top with lacquered wood legs	3020	213.40

76	78x78	21,25	1	0,078	80
----	-------	-------	---	-------	----

ESTRUCTURA FRAMEWORK	CÓDIGO CODE	COMPACTO COMPACT
3025 Tapa compacto con patas de madera lacada Table top with lacquered wood legs	3025	235.40

76	88x88	25,00	1	0,099	90
----	-------	-------	---	-------	----

ESTRUCTURA FRAMEWORK	CÓDIGO CODE	COMPACTO COMPACT
3030 Tapa compacto con patas de madera lacada Table top with lacquered wood legs	3030	243.10

76	108x68	26,50	1	0,095	70
----	--------	-------	---	-------	----

ESTRUCTURA FRAMEWORK	CÓDIGO CODE	COMPACTO COMPACT
3035 Tapa compacto con patas de madera lacada Table top with lacquered wood legs	3035	259.60

76	118x78	29,80	1	0,124	80
----	--------	-------	---	-------	----

IMPORT

IMPORT

Sillas | Mesas

Chairs | Tables

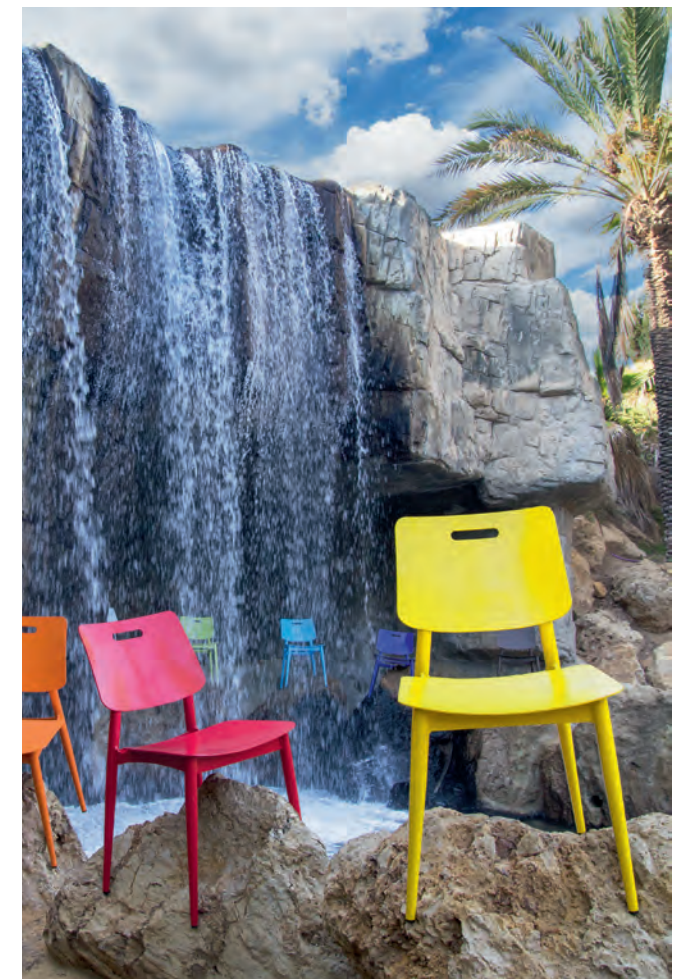

1903



ARTIC · Sillón con estructura, asiento y respaldo de aluminio con un acabado en pintura poliéster en diferentes colores.
 ARTIC · Armchair with structure, seat and back in aluminium thermolacquered in different colours.

ESTRUCTURA FRAMEWORK	CÓDIGO CODE	PINTURA PAINTING
Pintado en aluminio bicapa, o consultar colores <i>Painted in aluminium bilayer or see colors.</i>	1903L	99.00

h 85 h 45 h 60 h 56,5	kg 3,600	60	3,456
-----------------------------	----------	----	-------

- Apilable *Stackable*
- Útil para exteriores *Outdoor*

Pintura *Painting*

B	Y	A	7	J	3	T	G	N
---	---	---	---	---	---	---	---	---

1904



AQUA · Silla con estructura, asiento y respaldo de aluminio con un acabado en pintura poliéster en diferentes colores.
 AQUA · Chair with structure, seat and back in aluminium thermolacquered in different colours.

ESTRUCTURA FRAMEWORK	CÓDIGO CODE	PINTURA PAINTING
Pintado en aluminio bicapa, o consultar colores <i>Painted in aluminium bilayer or see colors.</i>	1904L	116.65

h 76 h 45 h 48 h 43	kg 4,000	4	0,370
---------------------------	----------	---	-------

- Sólo en interiores *Indoor*
- Útil para exteriores *Outdoor*

Pintura *Painting*

B	Y	A	7	J	3	T	L	N
---	---	---	---	---	---	---	---	---

1906



INDIAN · Silla con estructura, asiento y respaldo de aluminio con un acabado en pintura poliéster en diferentes colores.
 INDIAN · Chair with structure, seat and back in aluminium thermolacquered in different colours.

ESTRUCTURA FRAMEWORK	CÓDIGO CODE	PINTURA PAINTING
Aluminio pintado en diferentes colores <i>Painted aluminium</i>	1906	125.90

h 85 h 46 h 49 h 39	kg 3,200	2	0,650
---------------------------	----------	---	-------

- Sólo en interiores *Indoor*
- Útil para exteriores *Outdoor*

Pintura *Painting*

B	Y	A	7	J	3	T	G	N
---	---	---	---	---	---	---	---	---

1907



AZOV · Silla con estructura, asiento y respaldo de acero con un acabado en pintura poliéster en diferentes colores.
 AZOV · Chair with structure, seat and back in steel thermolacquered in different colours.

ESTRUCTURA FRAMEWORK	CÓDIGO CODE	PINTURA PAINTING
Pintado en aluminio bicapa, o consultar colores <i>Painted in aluminium bilayer or see colors.</i>	1907L	88.00

h 76 h 45 h 48 h 43	kg 4,000	4	0,370
---------------------------	----------	---	-------

- Sólo en interiores *Indoor*

Pintura *Painting*

B	Y	A	7	J	3	T	L	N
---	---	---	---	---	---	---	---	---





TGB THE GOOD BURGER

coffee Borkuff shop



TGB
THE GOOD BURGER





the Good Burger
Hamburguesas
GOOD MUSIC
your Bike



1901



Estructura de aluminio. Pintado en gris grafito. Apoya brazos en ECOWOOD. Asiento y respaldo en ratán negro.
 Frame in aluminium. Graphite grey coating. Armrest ECOWOOD. Seat and back in black rattan.

ESTRUCTURA FRAMEWORK	CÓDIGO CODE	RATAN RATTAN	Rattan Rattan -
Aluminio pintado en gris grafito <i>Painted in aluminium bilayer or see colors.</i>	1901	86.02	 RN

 Apilable Stackable
 Sólo en interiores Indoor
 Útil para exteriores Outdoor



Pintura Texturizada *Textured Paint*





R



1898



Sillón con estructura de aluminio y médula de rattán sintético de polipropileno. Color marrón y blanco.
 Armchair with aluminium structure and marrow polypropylene synthetic rattan. Brown and white color.

ESTRUCTURA FRAMEWORK	CÓDIGO CODE	POLIPROPILENO POLYPROPYLENE	Rattan Rattan -
Rattan <i>Rattan</i>	1898RGB 1898RQ	95.00	 RGB  RQ











 Apilable Stackable
 Útil para exteriores Outdoor

1899



Silla con estructura de aluminio y médula de rattán sintético de polipropileno. Color marrón y blanco.
 Chair with aluminium structure and marrow polypropylene synthetic rattan. Brown and white color.

ESTRUCTURA FRAMEWORK	CÓDIGO CODE	POLIPROPILENO POLYPROPYLENE	Rattan Rattan -
Rattan <i>Rattan</i>	1899RGB 1899RQ	83.00	 RGB  RQ











1882



Sillón con estructura de aluminio y médula de rattán sintético de polipropileno.
 Armchair and chair with aluminium structure and marrow polypropylene synthetic rattan.

ESTRUCTURA FRAMEWORK	CÓDIGO CODE	POLIPROPILENO POLYPROPYLENE	Rattan Rattan -
Rattan <i>Rattan</i>	1882RQ	95.00	 RG





 Apilable Stackable
 Útil para exteriores Outdoor



1902



Sillón con estructura de aluminio, asiento y respaldo de textilene.
 Armchair with structure in aluminium thermolacquered in different colours. Seat and back in textilene.

ESTRUCTURA FRAMEWORK	CÓDIGO CODE	PINTURA PAINTING
Pintado en aluminio bicapa, o consultar colores <i>Painted in aluminium bilayer or see colors.</i>	1902L	97.00

 Apilable Stackable
 Útil para exteriores Outdoor

Pintura *Painting*





B Y A 7 J 3 T G N



0219



Silla en resina de polipropileno.
 Chair of polypropylene resin.

ESTRUCTURA FRAMEWORK	CÓDIGO CODE	POLIPROPILENO POLYPROPYLENE
Polipropileno <i>Polypropylene</i>	0219	53.00

 Apilable Stackable
 Útil para exteriores Outdoor

Polipropileno *Polypropylene - R*





RB RQ



0217



Silla en resina de polipropileno.
 Chair of polypropylene resin.

ESTRUCTURA FRAMEWORK	CÓDIGO CODE	POLIPROPILENO POLYPROPYLENE
Polipropileno <i>Polypropylene</i>	0217	63.00

 Apilable Stackable
 Útil para exteriores Outdoor

1894



Silla con estructura de doble tubo de aluminio anodizado de 25mm. Asiento y respaldo de aluminio.
 Chair with double pipe aluminium anodized structure of 25 mm. Seat and back chair in aluminium.

ESTRUCTURA FRAMEWORK	CÓDIGO CODE	ALUMINIO ALUMINIUM
Anodizado Anodized	1894Z	47.00

Apilable Stackable
 Útil para exteriores Outdoor

0661



Mesa con estructura de Aluminio anodizado de doble tubo de 28 mm. Tapa en acero inoxidable.
 Table with anodized aluminium structure of double pipe of 28 mm. Cover in Stainless Steel.

ESTRUCTURA FRAMEWORK	CÓDIGO CODE	ACERO INOX STAINLESS STEEL
Anodizado Anodized	0661Z	72.00

Apilable Stackable
 Útil para exteriores Outdoor

1883



Silla con estructura de doble tubo en aluminio anodizado de 25mm. Asiento y respaldo de médula de polipropileno.
 Chair with double pipe aluminium anodized structure of 25 mm. Seat and back chair of polypropylene marrow.

ESTRUCTURA FRAMEWORK	CÓDIGO CODE	POLIPROPILENO POLYPROPYLENE
Anodizado Anodized	1883Z	49.00

Apilable Stackable
 Útil para exteriores Outdoor

Polipropileno Polypropylene - R



Negro Black
 Crema Cream

El color tiene una codificación diferente porque no corresponde con el resto del material.



0771 - 0881



Mesa con estructura de Aluminio anodizado de doble tubo de 28 mm. Tapa en acero inoxidable.
 Table with anodized aluminium structure of double pipe of 28 mm. Cover in Stainless Steel.

ESTRUCTURA FRAMEWORK	CÓDIGO CODE	ACERO INOX STAINLESS STEEL
0771 Anodizado Anodized	0771Z	105.00

ESTRUCTURA FRAMEWORK	CÓDIGO CODE	ACERO INOX STAINLESS STEEL
0881 Anodizado Anodized	0881Z	115.00

Apilable Stackable
 Útil para exteriores Outdoor

0891



Mesa con estructura de Aluminio anodizado de doble tubo de 28 mm. Tapa en acero inoxidable.
 Table with anodized aluminium structure of double pipe of 28 mm. Cover in Stainless Steel.

ESTRUCTURA FRAMEWORK	CÓDIGO CODE	ACERO INOX STAINLESS STEEL
Anodizado Anodized	0891Z	206.00
Acero inoxidable Stainless Steel	0891X	300.00

Acero Inoxidable (e:21mm) Stainless Steel - XX



Apilable Stackable
 Útil para exteriores Outdoor

0105



Silla con estructura de acero pintado en grafito. Asiento y respaldo en polietileno.
 Chair with steel structure graphite painted. Seat and back chair in polyethylene.

ESTRUCTURA FRAMEWORK	CÓDIGO CODE	POLIPROPILENO POLYPROPYLENE
Acero pintado grafito Graphite painted steel	0105	32.00
Plegable <i>Folding</i>		
Útil para exteriores <i>Outdoor</i>		

2820 - 2450



Mesa plegable con estructura de acero pintado en grafito. Tapa de polietileno.
 Folding table with steel structure graphite painted. Table top in polyethylene.

ESTRUCTURA FRAMEWORK	CÓDIGO CODE	POLIETILENO POLYETHYLENE
2820 Acero pintado grafito Graphite painted steel	2820	77.00
ESTRUCTURA FRAMEWORK	CÓDIGO CODE	POLIETILENO POLYETHYLENE
2450 Acero pintado grafito Graphite painted steel	2450	130.00
Plegable <i>Folding</i>		
Útil para exteriores <i>Outdoor</i>		

2180



Mesa plegable con estructura de acero pintado en grafito. Tapa de polietileno.
 Folding table with steel structure graphite painted. Table top in polyethylene.

ESTRUCTURA FRAMEWORK	CÓDIGO CODE	POLIETILENO POLYETHYLENE
Acero pintado grafito Graphite painted steel	2180	194.00
Plegable <i>Folding</i>		
Útil para exteriores <i>Outdoor</i>		

1892



Sillón con estructura de aluminio lacado en blanco. Asiento y respaldo de lamas ECOWOOD.
 Armchair with aluminum structure lacquered in white. Seat and back slats ECOWOOD.

ESTRUCTURA FRAMEWORK	CÓDIGO CODE	ARCE NATURAL NATURAL MAPLE
Aluminio Aluminium	1892	84.90
Apilable <i>Stackable</i>		
Útil para exteriores <i>Outdoor</i>		

1879



Sillón con estructura, asiento y respaldo de aluminio con un acabado en pintura poliéster en diferentes colores.
 Armchair with structure, seat and back in aluminium thermolacquered in different colours.

ESTRUCTURA FRAMEWORK	CÓDIGO CODE	PINTURA PAINTING
Pintado en aluminio bicapa, o consultar colores Painted in aluminium bilayer or see colors.	1879L	52.80
Apilable <i>Stackable</i>		
Útil para exteriores <i>Outdoor</i>		



ESTRUCTURAS METÁLICAS

METALIC STRUCTURESBicapa alum.
Aluminized dual layer LCromado
Chrome CAcero Inoxidable
Stainless Steel XAnodizado
Anodized ZNegro
Black NNegro Texturizado
Textured Black 2Blanco
White BBlanco Mate
Mate White 1Gris
Gray GNogal Mate
Walnut OHaya
Beech HCerezo
Cherry F

CARACTERÍSTICAS Y ACABADOS

*FEATURES & FINISHED***BICAPA ALUMINIZADO**

Tubo de acero fabricado por conformación en frío y calibrado exteriormente por una fabricación en continuo. El acabado en bicapa aluminizado se realiza mediante el tren de pintura que presenta un pre tratamiento de cinco fases. Las piezas son desengrasadas y preparadas. Secadas a 100°C en el horno se produce el proceso de cristalización del fosfato, característica que favorece una alta resistencia a la corrosión. El proceso posterior de pintura se realiza en polvo poliéster por aplicación vía electrostática a 80 kV y una vez aplicado se calienta en el horno a 200°C.

CROMADO

En nuestras instalaciones disponemos de un plataforma de proceso de baños electrolíticos donde se realizan los acabados superficiales de cromado.

ACERO INOXIDABLE

El acero inoxidable se define como una aleación de hierro con un mínimo de 10% de cromo contenido en masa. Es resistente a la corrosión, dado que el cromo, u otros metales que contiene, posee gran afinidad por el oxígeno y reacciona con él formando una capa pasivadora, evitando así la corrosión del hierro.

ANODIZADO

El tubo es una aleación de aluminio fabricado mediante un proceso de extrusión. La técnica del anodizado consiste en realizar una serie de procesos electro-químicos mediante óxidos que generan una capa de protección artificial, de manera que se consigue una mayor resistencia y durabilidad. El tubo de aluminio es de 1,5 mm de espesor y sus características técnicas son: resistencia a la rotura, a la cizalladura, a la corrosión, dureza extrema i peso ligero. El acabado anodizado es apto para uso en exteriores.

ALUMINIZED DUAL LAYER

Cold shaped steel pipe calibrated externally by continuous manufacturing. This aluminized dual layer finish is performed through the paint process, which has a five stage pre-treatment. Pieces are degreased and prepared. Dried at 100° in the furnace, it takes place the phosphate crystallization process, which favors a high resistance to corrosion. The following painting process is done by electrostatic application of polyester powder at 80 kV. Once applied, it is heated in the furnace at 200°

CHROMED

In our facilities we have available one platform of electrolytic baths process where chrome finish is done.

STAINLESS STEEL

Stainless steel is defined as an iron alloy with a minimum of 10% of chromium content in mass. It is corrosion resistant, since chrome, or other metals it contains, has great affinity for oxygen and reacts with it forming a passivating layer, thus preventing the corrosion of iron.

ANODIZED

The pipe is an alloy of aluminum made by means of an extrusion process. Anodizing technique consists of conducting a series of electrochemical processes by oxides, generating an artificial protective layer, so that a higher resistance and durability is achieved. The aluminum pipe is 1.5 mm thick and its technical features are: resistance to breakage, resistance to plate shears, resistance to corrosion, extreme hardness and light weight. The anodized finish is suitable for outdoor use.

LA CARTA DE COLORES QUE AQUÍ SE EXPONE ES UNA REPRODUCCIÓN IMPRESA Y PUEDEN EXISTIR DESVIACIONES CROMÁTICAS RESPECTO AL COLOR ORIGINAL

POLIURETANO (CÓDIGO I)

POLYURETHANE (CODE I)



Naranja Orange IJ Rojo Red IT Burdeos Bordeaux IU Pistacho Pistachio I3 Negro Black IN

El poliuretano (PUR) es un material flexible. Su moldeado por inyección permite conformar el asiento y el respaldo con el acolchado adecuado. Es un producto recomendado para interiores y de fácil limpieza.

Polyurethane (PUR) is a flexible material. its shape allows injection molded seat and backrest with suitable padding, this product is recommended for indoor use and easy to clean.

POLIPROPILENO (CÓDIGO R)

POLYPROPYLENE (CODE R)

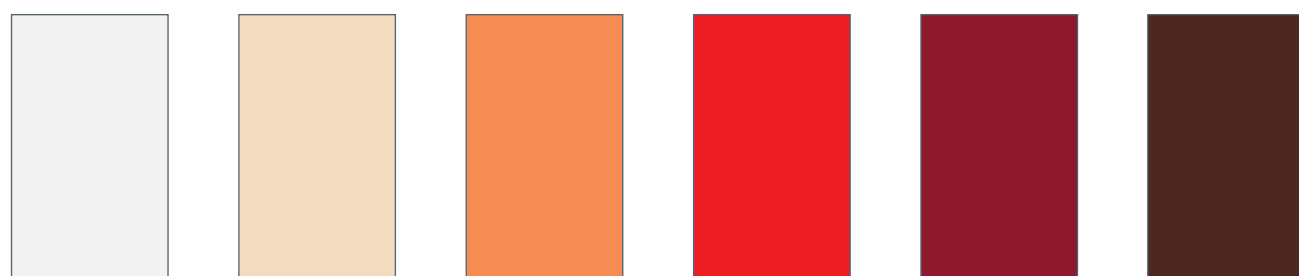

Blanco White RB Crema Cream-colour RK Naranja Orange RJ Rojo Red RT Burdeos Bordeaux RU Chocolate Brown RQ

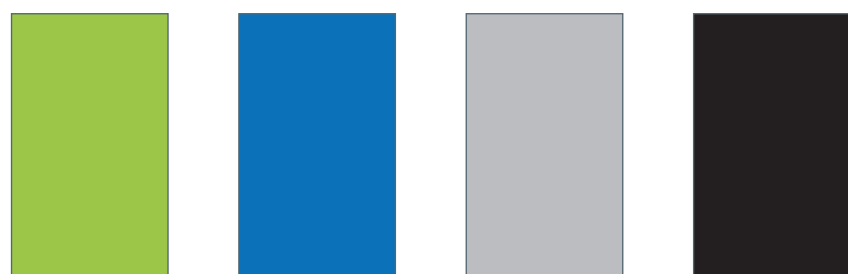

Pistacho Pistachio R3 Azul Blue RA Gris Grey RG Negro Black RN

El Polipropileno (PP) es un material técnico que RIPAY ofrece con máximas garantías para su utilización tanto en interior como exterior.

Es un polímero termoplástico, que se obtiene de la polimerización del polipropileno (o propeno), copolímero de 3,5 de fluidez, módulo de tracción 1200 MPA. El plástico es aditivado con productos específicamente desarrollados por químicas especializadas para RIPAY. Se inyecta en el molde a una temperatura superior a la de transición vítrea a 1500 bar de presión.

Como características técnicas importantes :

Resistencia al impacto Charpy con entalla 60 KJ/m²

La protección ultravioleta garantiza la duración de la pieza en condiciones climáticas más adversas y solidez a la luz.

Material antiestático eliminando la electricidad estática facilitando la limpieza del producto

Polypropylene (PP) is a technical material with maximum guarantees that RIPAY provides for use both indoors and outdoors.

Is a thermoplastic polymer, obtained by the polymerization of polypropylene (or propylene) copolymer, 3.5 melt flow, tensile modulus of 1200 MPa. Plastic is additive with products specifically developed for specialized chemical for RIPAY. is injected into the mold at a temperature above the glass transition pressure to 1500 bar. As important technical features:

Charpy impact strength notched 60 KJ/m².

UV protection ensures the length of the piece in the most adverse weather conditions and light fastness.

Antistatic material eliminating static electricity making cleaning product.

LA CARTA DE COLORES QUE AQUÍ SE EXPONE ES UNA REPRODUCCIÓN IMPRESA Y PUEDEN EXISTIR DESVIACIONES CROMÁTICAS RESPECTO AL COLOR ORIGINAL

POLIPROPILENO REF. 2011 (CÓDIGO R)

POLYPROPYLENE REF. 2011 (CODE R)



Crema Cream-coloured RK Ocre Ocher RR Chocolate Brown RQ Blanco White RB Negro Black RN MODELO 2011



POLIPROPILENO / COLORES EXCLUSIVOS REF. 561 (CÓDIGO R)

POLYPROPYLENE / EXCLUSIVE COLORS REF. 561 (CODE R)



Azul Blue RA Burdeos Bordeaux RU Negro Black RN Crema Cream-coloured RK Verde Green RV MODELO 561



POLIPROPILENO / COLORES EXCLUSIVOS REF. 116, 1875 (CÓDIGO R)

POLYPROPYLENE / EXCLUSIVE COLORS REF. 116, 1875 (CODE R)



Burdeos Bordeaux RU Azul Blue RA Crema Cream-coloured RK Verde Green RV



MODELO 116

MODELO 1875

REGRUESADO (espesor: 40 mm)

THICKNESS (THICKNESS: 40 mm)

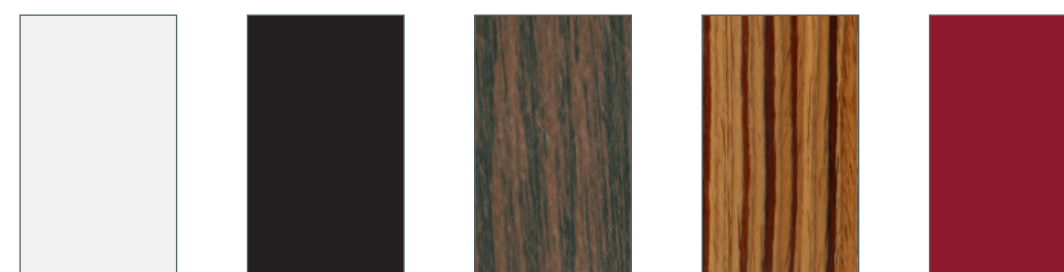

Blanco White GB Negro Black GN Wengué Wenge GW Zebrano Zebrano GZ Burdeos Bordeaux GU

El regruesado es un material compuesto por una lámina de 0,8 mm con las mismas características técnicas mencionadas anteriormente para el Compacto de 10 mm. Esta lámina cubre toda la superficie y cantos del tablero aglomerado ultralight de 40 mm de baja densidad, mediante un proceso de pegado a presión. A diferencia del compacto, esta material sólo se recomienda para uso en interiores.

The thickening is a composite material with a sheet of 0.8 mm. of compact laminate. This film covers the entire surface and edges of chipboard 40 mm ultralight. Low density, through a pressure bonding process. Unlike compact, this material is only recommended for indoor use.

COMPACTO (espesor: 10 mm) (CÓDIGO C)

COMPACT (thickness: 10 mm) (CODE C)

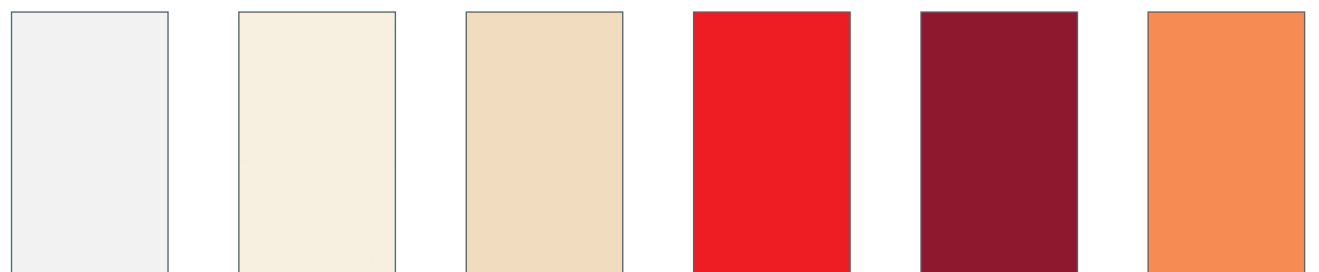

Blanco White CB Marfil Ivory C6 Crema Cream-coloured CK Rojo Red CT Burdeos Bordeaux CU Naranja Orange CJ



Pistacho Pistachio C3 Azul Blue CA Negro Black CN Gris Grey CG Roble Oak CE Nogal Walnut CO



Wengué Wenge CW

COMPACTO DECORADO (espesor: 10 mm) (CÓDIGO 2)

DECORATED COMPACT (thickness: 10 mm) (CODE C)



Magic Negro Black Magic 2N Magic Blanco White Magic 2B Inox Gris Grey Inox 2X

El compacto es un material técnico y de máximas garantías que RIPAY ofrece en mesas y sillas, tanto para exterior como para interior. Se trata de una lámina de 10 mm de espesor compuesta por láminas de fibra termo-endurecidas con resinas fenólicas a presiones extremas (5 MPa) y altas temperaturas (120°C), que permite que las resinas termoestables fluyan y posteriormente curen para dar lugar a un material homogéneo no poroso de mayor densidad (1,35 grs/cm3). El acabado superficial para el compacto saturado y de alto brillo se logra con los llamados espejos, que son planchas de metal a brillo espejo o grabadas.

Como características técnicas certificadas por la Unión europea están:

- Fácil limpieza: Es un material inerte, totalmente higiénico. Tiene la característica de no disponer de cantos o juntas de ningún tipo y evita la acumulación de residuos. Se limpia fácilmente con agua jabonosa y permite medios más agresivos como vapor, disolvente de trementina o de acetona.
- Salubridad: Presenta resistencia elevada a la generación de hongos y bacterias según la norma ISO 846. Cumple también con la norma ENV 1186 "Materiales y artículos en contacto con productos alimentarios"
- Resistencia al desgaste superficial: Elevada dureza debido a laminados compactos que se fabrican con una capa alúmina, uno de los materiales más duros de la naturaleza (ISO 9352). Extremadamente resistente al rallado, la abrasión, a quemaduras y a limpiezas frecuentes.
- Resistencia al vapor de agua: Es impermeable y resistente a la humedad (UNE 438).
- Resistencia al calor seco y choque climático: El compacto tiene un tratamiento superficial especial para resistir la radiación ultra-violeta, evitando la degradación de los colores (UNE 438). Simulación cámara climática EN 438.
- Ignifugo: Resistente al fuego, lo que retarda su inflamabilidad.

The compact is a high technical material of maximum guarantees offered by RIPAY furniture, available for outdoor and indoor. It's a sheet of 10 mm. thick fiberboard composed of thermoset phenolic resin extreme pressure (5MPa) and high temperatures (120o), allowing the thermosetting resin to flow and then cure to give a homogeneous non-porous material of higher density (1.35 grs/cm3). The surface finish for the compact saturated and high brightness is achieved with so-called mirrors, which are metal plates or engraved mirror shine.

As specifications certified by the European Union are:

- Easy to cleaning: It's an inert, completely hygienic. It has the characteristic of having no edges or joints and prevents any buildup. Easily cleaned with soapy water and allows more aggressive media such as steam, solvent turpentine or acetone.
- Resistance to surface wear: High hardness due to compact laminates are manufactured with an alumina layer, one of the hardest materials in nature (Iso 9352). Extremely scratch-resistant, abrasion burns and frequent cleaning.
- Water vapor resistance: It is waterproof and moisture resistant (EN438).
- Resistance to dry heat-shock and climate: The compact has a special surface treatment to withstand ultraviolet radiation, preventing color fade (UNE438). Simulation climatic chamber EN438.
- Fire retardant: retarding its flammability.

ABS MADERA Y LISOS (CÓDIGO G)

WOOD ABS (CODE G)



Haya Beech GH Wengué Wenge GW Blanco White GB Negro Black GN Nogal Walnut GO Marrón Brown GQ

El Acrilonitrilo Butadieno Estireno o ABS es un plástico muy resistente al impacto. Su estructura química proporciona rigidez, resistencia a ataques químicos y estabilidad a alta temperatura así como dureza. El rasgo más importante del ABS es su tenacidad, incluso a baja temperatura.

Acrylonitrile butadiene styrene or ABS is a high impact plastic. Its chemical structure provides stiffness and resistance to chemical attack at high temperature stability and hardness. The most important feature of ABS is its toughness, even at low temperature.

MADERA - SILLAS (CÓDIGO M)

WOOD - CHAIRS (CODE M)

Ref.: 211, 1211, 1210, 519, 453, 480, 570, 226, 526, 596, 208, 571, 202, 145, 207, 210, 172, 174, 1554, 594, 598, 592, 595, 597



Haya Beech MH Cerezo Cherry MF Nogal Walnut MO Zebrano Zebrano MZ Wengué Wenge MW

Madera de haya de 30 mm de espesor y post-formado proporcionando ergonomía y diseño a las sillas de RIPAY.

Lacado de varios colores y con la particularidad de disponer de acabados bicolor. Al tratarse de un material natural pueden producirse pequeñas diferencias de tono entre partidas. Apto para uso en interior, resguardar del sol y de la humedad.

Beechwood 30 mm. thick post formed providing ergonomics and design RIPAY chairs. Lacquered in various colours and with the particularity of having bicolor finishes. Being a natural material can cause slight differences in tone between games. Suitable for indoor use, protect from sun and moisture.

MADERA - MESAS (CÓDIGO M)
WOOD - TABLES (CODE M)

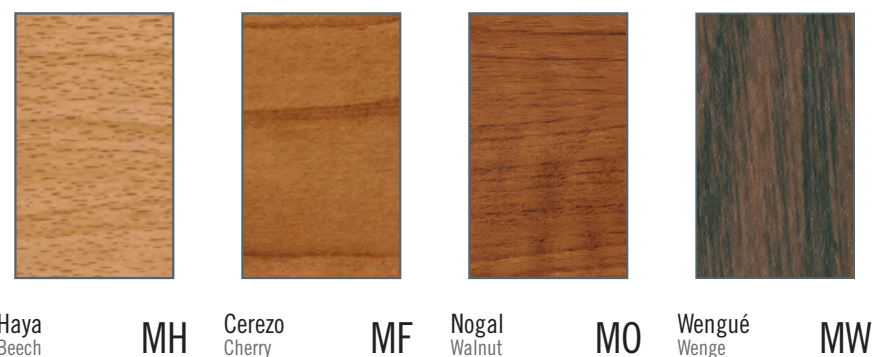

Haya Beech **MH** Cerezo Cherry **MF** Nogal Walnut **MO** Wengué Wenge **MW**

MADERA - MESAS (CÓDIGO M)
WOOD - TABLES (CODE M)



Haya Beech **MH** Cerezo Cherry **MF** Nogal Walnut **MO** Wengué Wenge **MW**

Blanco White **MB** Negro Black **MN** Plata Silver **MG**

Madera de haya de 30 mm de espesor y post formado proporcionando ergonomía y diseño a las sillas de RIPAY. Lacado de varios colores y con la particularidad de disponer de acabados bicolor. Al tratarse de un material natural pueden producirse pequeñas diferencias de tono entre partidas. Apto para uso en interior, resguardar del sol y de la humedad.

Beechwood 30 mm. thick post formed providing ergonomics and design RIPAY chairs. Lacquered in various colours and with the particularity of having bicolor finishes. Being a natural material can cause slight differences in tone between games. Suitable for indoor use, protect from sun and moisture.

ESTRATIFICADO - SILLAS (CÓDIGO E)
STRATIFIED - CHAIRS (CODE E)



Blanco White **EB** Burdeos Bordeaux **EU** Negro Black **EN** Roble Oak **EE**

Nogal Walnut **EO** Wengué Wenge **EW** Zebrano Zebrano **EZ**

MADERA PINO (CÓDIGO MP)
WOOD PINE (CODE MP)



Rojo Red **MPT** Marrón Brown **MPO** Gris Grey **MPG** Crema Cream **MPK** Blanco White **MPB** Natural Natural **MP**

Madera de pino de 19 mm de espesor. Lacado de varios colores. Al tratarse de un material natural pueden producirse pequeñas diferencias de tono entre partidas. Apto para uso en interior, resguardar del sol y de la humedad.

Beechwood 19 mm. thick. Lacquered in various colours. Being a natural material can produce small differences in tone between pieces. Suitable for indoor use, protect from sun and moisture.

POLIPIEL (CÓDIGO L)
IMITATION LEATHER (CODE L)

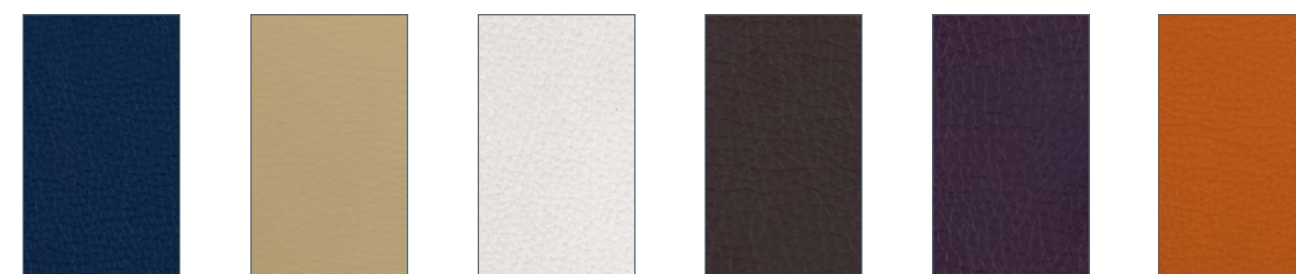

Azul Marino Navy Blue **LA** Beig Fawn **LK** Blanco White **LB** Chocolate Chocolate **LB** Lila Purple **LB** Naranja Orange **LU**



Negro Black **LN** Pistacho Pistacho **L3** Rojo Red **LU**

TELAS INTERIOR (CÓDIGO T)
FABRICS FOR INTERIOR (CODE T)

Ref.: 9001, 9003, 9004, 9005, 9006, 9007, 9008, 9009, 9010, 9011, 9012, 9014, 9015, 9016, 9017, 9018.

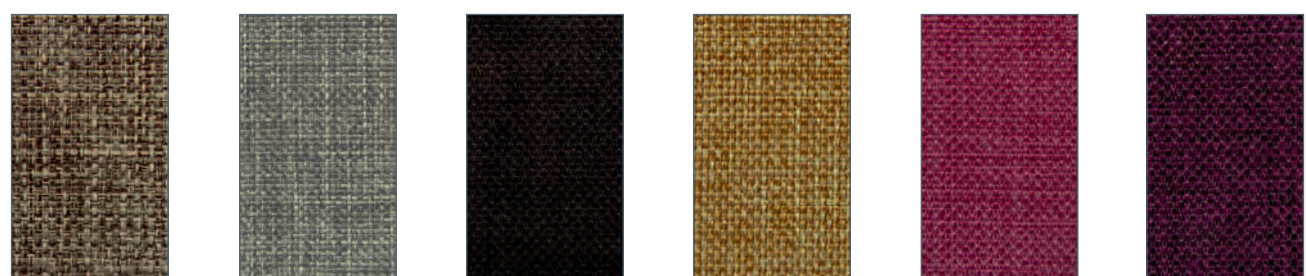

T104 T105 T107 T109 T116 T117

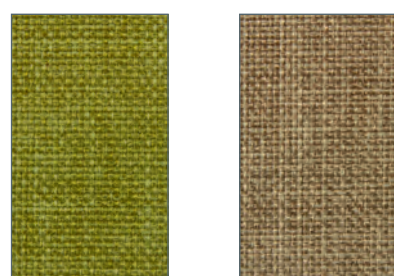

T112 T102

POLIPIEL EXTERIOR (CÓDIGO L)
IMITATION LEATHER (CODE L)

Ref.: 1153, 1140, 1190, 1192, 1194, 1195, 545, 500

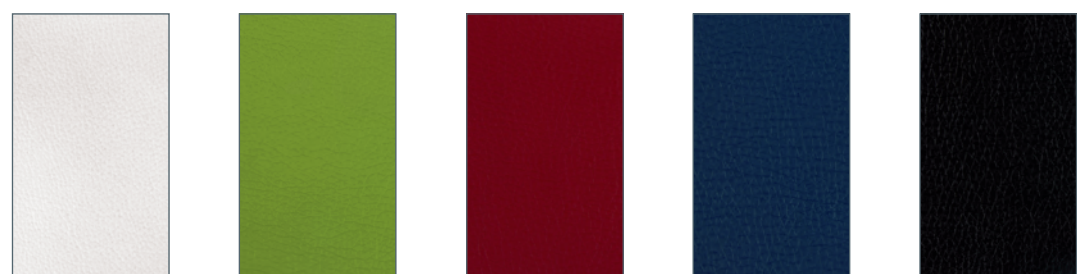

Blanco White LB Pistacho Pistacho L3 Burdeos Bordeaux LU Azul Marino Navy Blue LA Negro Black LN

La polipiel es un material compuesto de PVC (87%), Algodón (6,5 %) y Polyester (6,5 %). Sus condiciones ignifugas son ideales para la utilización en lugares públicos donde el material está expuesto a diferentes tratamientos y supone mayor desgaste. Las propiedades ignifugas.

Las características técnicas más significativas para este material son:

- Transpirable
- Resistencia a la abrasión: UNE-EN ISO 12947-2:1999 + 80.000 ciclos.
- Inflamabilidad: Al cigarrillo, UNE-EN 1021 -1: 2006 y a la cerilla UNE-EN 1021- 2 : 2006



CRISTAL 10 mm (CÓDIGO Q)
CRYSTAL 10 mm (CODE Q)



Opaco Opaque Q0 Transparente Transparent QS

CRISTAL TEMP. 5 mm (CÓDIGO Q)
TEMP. CRYSTAL 5 mm (CODE Q)

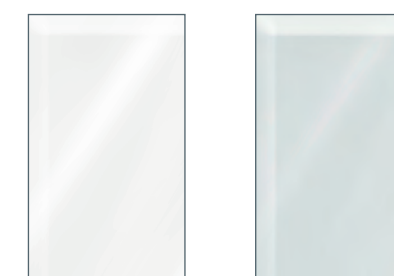

Opaco Opaque Q0 Transparente Transparent QS

REF: 8008

CRISTAL COLORES 10 mm (CÓDIGO Q)
COLOURS CRYSTAL 10 mm (CODE Q)

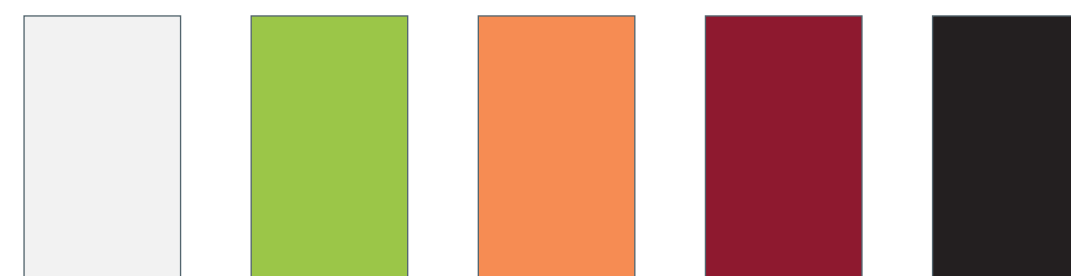

Blanco White QB Pistacho Pistachio Q3 Naranja Orange QJ Burdeos Bordeaux QU Negro Black QN

El vidrio templado, se obtiene por un proceso de fabricación térmica. El vidrio flotado se calienta gradualmente hasta una temperatura de reblandecimiento de entre 575 y 635 grados Celsius para después enfriarlo muy rápidamente con aire. De esta manera se consigue que el vidrio quede expuesto en su superficie a tensiones de compresión y en el interior a tensiones de tracción, confiriéndole mayor resistencia estructural y al impacto que el vidrio sin tratar, teniendo la ventaja adicional de que en caso de rotura se fragmenta en pequeños trozos inofensivos.

Como características técnicas importantes para el vidrio:

- La resistencia a la flexión del vidrio recocido al templar aumenta desde 400 kp/cm2 hasta 1.200 - 2.000 kp/cm2, lo que equivale de 4 a 5 veces la resistencia de un vidrio normal.
- La resistencia al choque térmico, pasa de 60 °C a 240 °C.

ACERO INOXIDABLE 21 mm (CÓDIGO X)
STAINLESS STEEL 21 mm (CODE X)

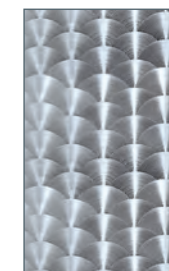

Inoxidable Stainless X

PINTURA BRILLO

PAINTING BRIGHTNESS (CODE P)

Ref: 774, 784, 794,1903,1904,1907,1906

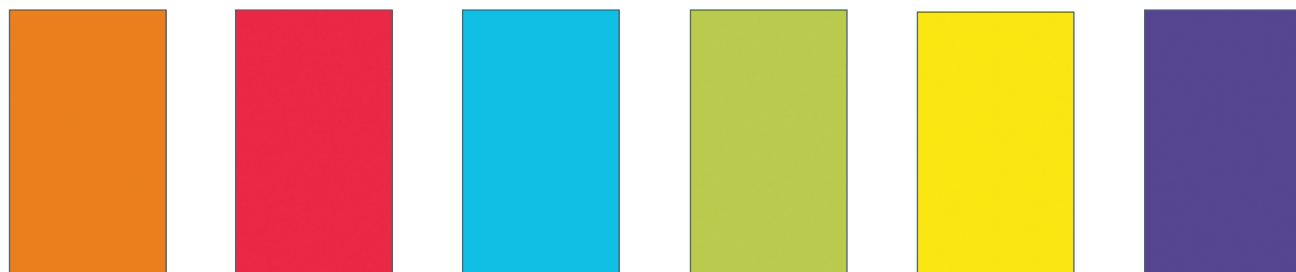

Naranja Orange J Rojo Red T Azul Blue A Pistachio Pistachio 3 Amarillo Yellow I Morado Purple 7

PINTURA TEXTURIZADA

TEXTURED PAINT



Negro Black 2 Blanco White 1 Gris Grey 5 Nogal Walnut 0

CONDICIONES GENERALES DE VENTA

GENERAL CONDITIONS OF SALE

PRECIOS

En esta tarifa se indican los precios de venta recomendados por el fabricante. Los precios netos se incrementarán con el IVA vigente.

FORMA DE PAGO

Las formas de pago aceptadas serán:

Contado o Giro domiciliado al cobro con el 1% de descuento p.p.

Giro domiciliado a 60 días máximo fecha factura.

No serán aceptados pagarés o transferencias bancarias como nuevas formas de pago, en sustitución del giro domiciliado.

Para nuevos clientes, el pago del primer pedido se realizará al contado.

Los pedidos de productos especiales se abonarán en un 30% por adelantado y el resto en la forma de pago habitual del cliente.

Los pedidos superiores a 450 € estarán libres de portes en península, pedidos de importe inferior tendrán un cargo de portes adicional.

PEDIDOS

Los pedidos se pueden tramitar por e-mail (pedidos@ripay.es) o fax (+ 34 96 656 0689). Para admitir un pedido éste deberá ser tramitado por escrito a fábrica con toda la información necesaria para la identificación de modelos, acabados y precios, reservándose el fabricante el derecho de admitir o rechazar pedidos especiales que no se ajusten a los modelos y acabados indicados en la presente tarifa.

RIPAY, S.A.U. no aceptará ningún pedido si no cuenta con los datos bancarios (C.C.C.) del cliente a fin de enviar la factura comercial y emitir el correspondiente efecto a su cargo con el vencimiento indicado en la misma.

PORTES

Los precios indicados en esta tarifa corresponden a la mercancía situada en nuestras instalaciones o en las delegaciones correspondientes.

No tendrán recargo de portes los pedidos superiores a 450 € para Península y 600€ para Baleares. Los pedidos inferiores tendrán un recargo en factura equivalente al coste de envío de acuerdo con las tarifas de nuestra Agencia de transportes habitual.

INCIDENCIAS

Los envíos por agencia están cubiertos por un seguro ante posibles desperfectos. Si observan cualquier desperfecto deberán comunicarlo a fábrica por escrito (fax o e-mail) durante las 24 horas siguientes a la entrega. En cualquier caso recomendamos indiquen en el albarán de la agencia "Mercancía Pendiente de Revisión" y procedan a dicha revisión dentro del plazo indicado.

DEVOLUCIONES

Sólo se admitirán devoluciones de mercancía previa autorización por escrito por parte de RIPAY, S.A.U. Los portes de devolución y re-envío de mercancía correrán por cuenta del cliente.

La mercancía devuelta se abonará en un 80% de su valor tras su revisión y comprobación de que se encuentra sin usar y en perfecto estado. No se aceptarán devoluciones de productos con medidas y/o acabados especiales.

RIPAY, S.A.U. no aceptará penalizaciones por retrasos en la entrega siempre que no haya un acuerdo escrito firmado por ambas partes que así lo determine.

IMPAGADOS

El envío de mercancías será el normalizado siempre que no existan impagados. En este caso se suspenderá cualquier suministro hasta la liquidación total del mismo. El mobiliario es propiedad de RIPAY S.A.U. hasta que se efectúe el pago en su totalidad.

GASTOS E INTERESES

En el caso de producirse alguna devolución del efecto domiciliado, repercutirá al deudor un recargo del 6 % por gastos financieros sobre el importe devuelto. (Comisión mínima 30 €.)

El incumplimiento del pago que supere los sesenta días de la fecha factura, supondrá al deudor un recargo del tipo legal de interés de demora, determinado conforme a lo dispuesto en el artículo 7 de la Ley 3/2004, de 29 de diciembre.

RIPAY, S.A.U. se reserva el derecho a realizar modificaciones técnicas, medidas y precios. Queda prohibida la reproducción total o parcial de cualquier imagen sin la autorización previa de RIPAY, S.A.U. En caso de litigio, sólo serán válidos los Juzgados y Tribunales de la provincia de Alicante.

ESTA TARIFA ANULA A LAS ANTERIORES
QUEDAN NULOS LOS ARTÍCULOS QUE NO FIGURAN EN ESTA TARIFA



Nuestro mobiliario en
Mi casa es la tuya.

ripay
PREMIUM



ÍNDICE GENERAL

GENERAL INDEX

REF.	Nº PÁGINA	REF.	Nº PÁGINA	REF.	Nº PÁGINA	REF.	Nº PÁGINA	REF.	Nº PÁGINA
SILLAS Y TABURETES									
27	27	597	62	715	104	1054	108	825	124
29	27	599	60	718	104	1060	91	839	118
43	46	1140	58	721	112	1061	91	925	124
44	42	1150	56	740	105	1070	98	1179	119
72	55	1153	56	769	72	1071	98	1579	122
74	55	1169	21	779	72	1072	98	3015	125
116	41	1167	26	771	78	1073	93	3020	125
140	58	1175	44	774	80	1074	93	3025	125
145	53	1180	42	775	79	1081	102	3030	125
149	58	1190	58	779	72	1082	102	3035	125
151	56	1192	59	777	74	1083	89	3050	123
167	20	1194	59	784	80	1084	89	3051	123
169	14	1195	59	785	80	1086	89	3052	123
175	44	1211	45	787	74	1087	89	3060	124
180	35	1800	37	788	74	1088	89	3061	124
199	50	1875	41	790	97	1089	89	3062	123
201	52	2004	29	792	96	1092	88	3162	123
202	49	2005	40	793	97	1093	88	9007	121
203	49	2011	30	794	96	1094	88	9008	120
207	53	2012	32	795	96	1098	88	9011	120
208	47	2016	32	797	96	1099	88	9013	121
210	53	2018	32	801	110	1669	73	9019	120
211	45	2019	34	802	110	4000	84	9023	121
216	40	BANCADAS		803	110	4001	87	9500	122
226	48	5180	66	804	110	4002	81	9501	122
230	56	5207	67	829	83	4003	81	9523	123
280	37	5211	67	869	72	4004	81	IMPORT	
300	28	5216	68	875	79	4005	84	105	136
480	46	5575	69	881	78	4010	84	217	133
467	23	MESAS		888	83	4015	84	219	133
469	19	605	106	975	79	4021	86	661	135
510	64	607	83	1000	107	4022	86	771	135
518	39	608	106	1001	110	4023	86	881	135
519	45	612	101	1002	107	4024	86	891	135
521	63	614	101	1003	95	4027	85	1879	137
522	63	615	101	1004	107	4028	85	1882	132
523	64	616	112	1009	95	4029	85	1883	134
526	48	620	103	1010	107	4200	81	1892	137
528	39	623	103	1011	110	4205	81	1894	134
543	62	625	103	1012	107	4210	81	1898	132
550	57	627	103	1014	107	9988	99	1899	132
551	57	628	103	1016	92	9995	111	1901	132
552	57	629	103	1017	93	COMPL. EXTERIOR			
553	62	630	100	1018	92	8002	115	1902	133
554	55	640	100	1019	94	8005	116	1903	128
556	27	644	100	1020	94	8006	114	1904	128
561	60	654	100	1022	92	8007	114	1906	128
567	23	660	82	1023	94	8008	114	1907	128
569	18	661	78	1024	92	8010	116	2180	136
570	47	667	82	1029	94	8011	116	2450	136
571	47	671	112	1040	108	8012	115	2820	136
573	62	693	105	1041	90	8013	115		
575	44	694	105	1042	90	8014	115		
576	44	695	82	1043	90	8015	116		
577	49	698	97	1044	90	8016	114		
580	42	699	97	1045	90	MADERA			
593	61	700	109	1046	90	530	118		
594	60	701	98	1047	91	532	118		
595	62	702	109	1048	91	536	118		
596	48	710	104	1050	108	725	124		
		712	104	1052	108	739	118		

ripay

Polígono Industrial 1 · Avda. de Portugal, 25 · 03420 Castalla (Alicante) ESPAÑA

Tel.: 966 560 805 · Fax: 966 560 689 · Att. Cliente: 902 511 751

mail: atencionalcliente@ripay.es

DELEGACIONES RIPAY

SEVILLA

Polígono Calonge C/ Acero, 4 · 41007 Sevilla

Tel.: 954 317 224 · Fax: 954 354 352

mail: fernandezyacevedo@hotmail.com

ALMERÍA

Ctra. Sierra Alhamilla, 288 Naves 1 y 2 · 04007 Almería

Tel.: 950 223 588 · Móvil: 661 968 057 · Fax: 950 228 369

mail: ripay.almeria@ripay.es

MÁLAGA

Polígono el Viso · C/ Alcalde Gómez Gómez, 13 · 29006 Málaga

Tel.: 952 233 305 - 605 966 634

mail: malaga@ripay.es

CÓRDOBA

Polígono Los Metalúrgicos · C/ Pedroche · Nave 49 · 14014 Córdoba

Tel.: 957 440 018 · Fax: 957 435 964

mail: ripay.cordoba@ripay.es

CÁDIZ

C/ Marroquinería 5 · 11500 El puerto de Santa María (Cádiz)

Tel.: 615 078 630

mail: ripay.cadiz@ripay.es

TARRAGONA

Ctra. de Montblanc, 136 N-1 · 43206 Reus (Tarragona)

Tel.: 977 317 747 · Fax: 977 317 748

mail: ripay.tarragona@ripay.es

MURCIA

Pol. Cabezo · C/ Bucarest, Parcela 35-36 · 30395 Cartagena (Murcia)

Tel.: 968 321 321

mail: ripay.murcia@ripay.es

www.ripay.es





Polígono Industrial 1 · Avda. de Portugal, 25 · 03420 Castalla (Alicante) ESPAÑA
Tel.: 966 560 805 · Fax: 966 560 689 · Att. Cliente: 902 511 751
mail: atencionalcliente@ripay.es



www.ripay.es